

GRAND OPENINGS BY UDI, INC

STEPS TO ORDERING

1. Choose your style:

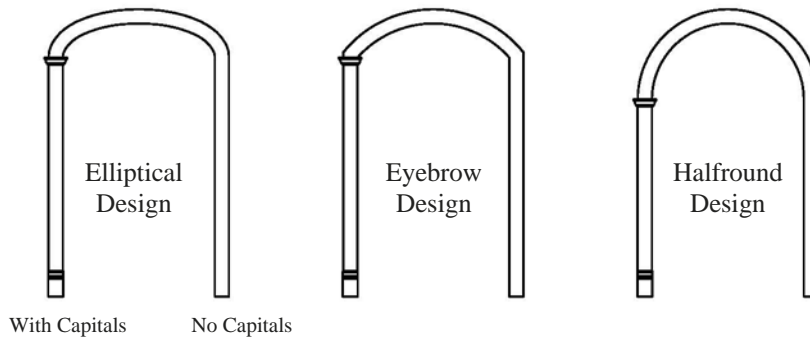

Horizontal Extension Design

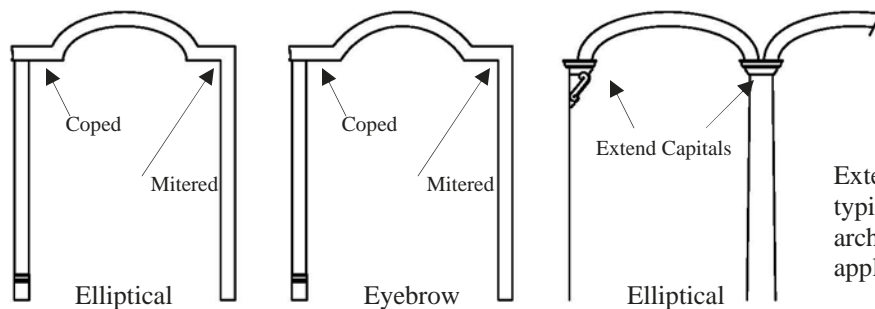

Extended Capitals are typically used in arcade of arches or with larger corbel applications.

2. Choose your Rise:

- 12” or 20” (20” rise is only suggested for ceilings heights 10’ and greater, see page 6)

3. Choose your Model Size (see diagram, “W”):

- The Model Size is determined by the Rough Opening Width
 - Elliptical Design (see page 15-16)
 - Eyebrow Design (see page 20-21)
 - Halfround Design (see page 22)
 - Horizontal Extension Design (see page 25-36)

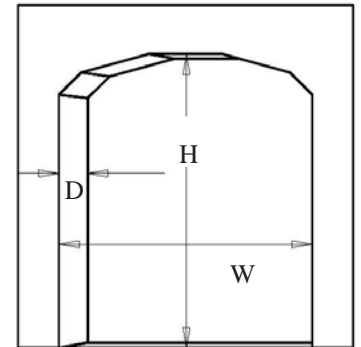

4. Choose your Finished Wall Thickness:

- See Diagram, “D” (Be sure to include sheetrock in thickness)

5. Choose your Profile (See Page 8-9):

6. Choose your Decorative Accents (Please refer to page 37 for compatibility) :

- Capital (Optional, p.8)
- Backband (Optional, p.9)
- Keystone Style (Mandatory for Model Sizes 108 and Larger)
- Recessed Panel (Optional for Wall Thickness 6 9/16” and greater, see page 10-11)
- Round Fluted Pilaster (Optional, see pages 8-9)

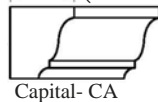

Capital- CA

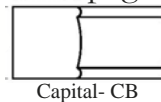

Capital- CB



Keystone-KA



Keystone-KB



Keystone-KC

7. Header Height (see diagram, “H”)

8. Start your project, Refer to Framing Instructions starting on page 14. Single page framing instructions for each Model Size are available on our website.

GRAND OPENINGS BY UDI, INC

12" AND 20" RISE OPTIONS

Grand Openings Elliptical and Eyebrow systems are available with a standard 12" rise or a optional 20" rise. This optional 20" rise is only recommend for applications with at least 10' ceilings and especially on Models 102 and greater. The taller rise makes better use of the ceiling height by allowing more height to be devoted to the arch. Both 12" and 20" rise can be used in the same application. However, for the capitals to align, the 12" rise header would need to be placed 8" below the 20" rise header.

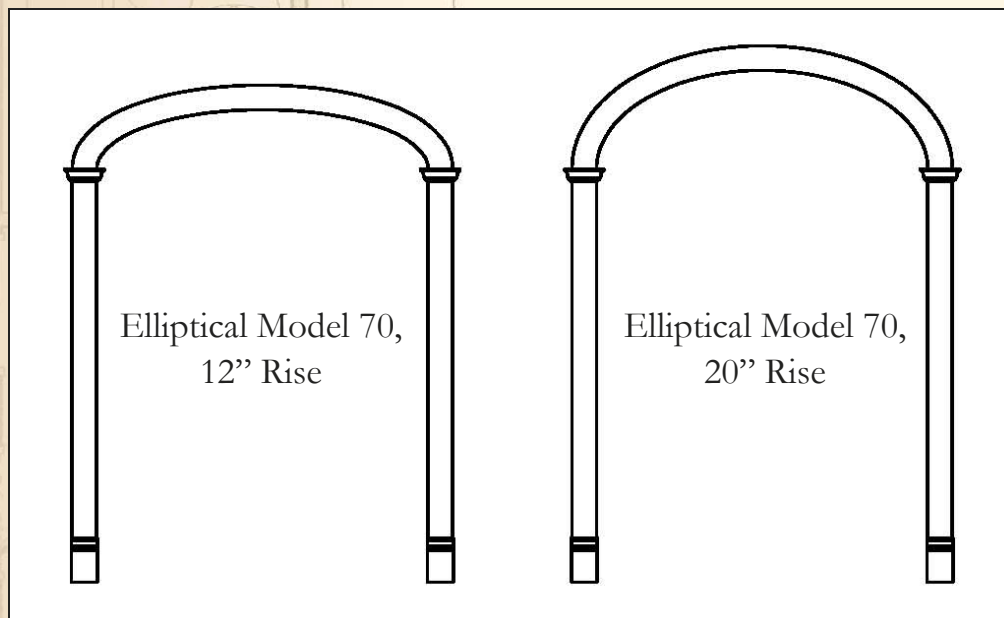
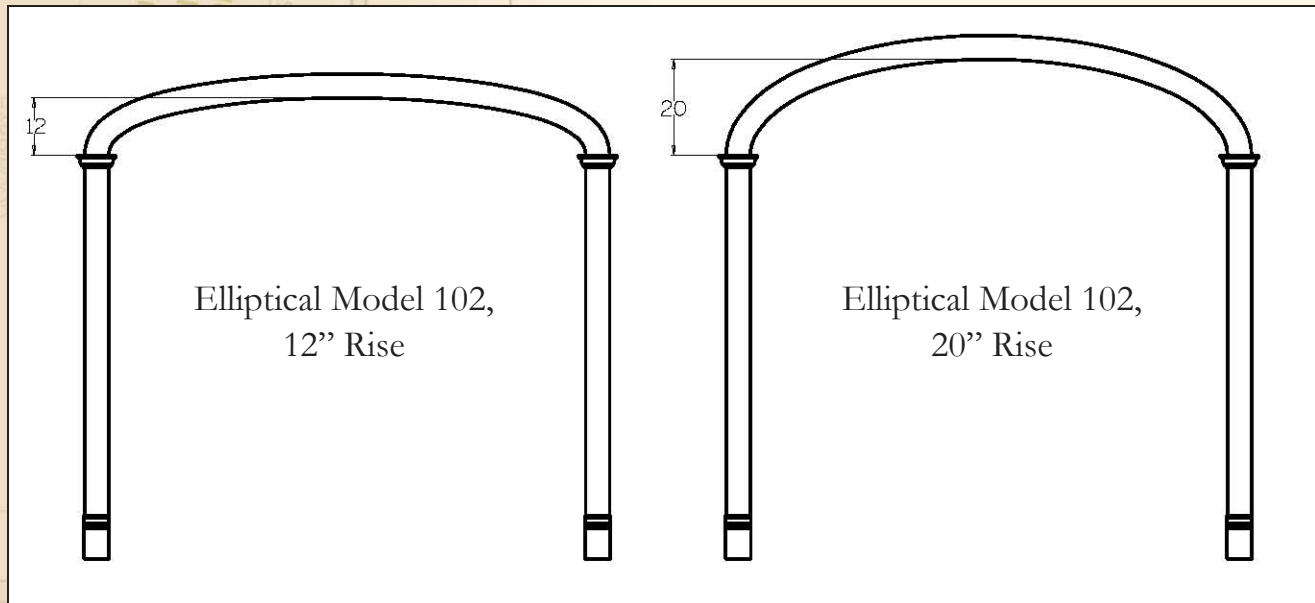

Elliptical Units Model 30 thru Model 42 with a 20" rise, actually become a true halfround. To allow for proper capital alignment, the elliptical units Model 30 thru Model 42 with a 20" rise will have straight added to the curved header unit. When wanting to achieve the "Elliptical" Design, a 12" rise on the units Model 42 and smaller should be considered. (Capitals will align when the 12" rise header is placed 8" below the 20" rise header.)

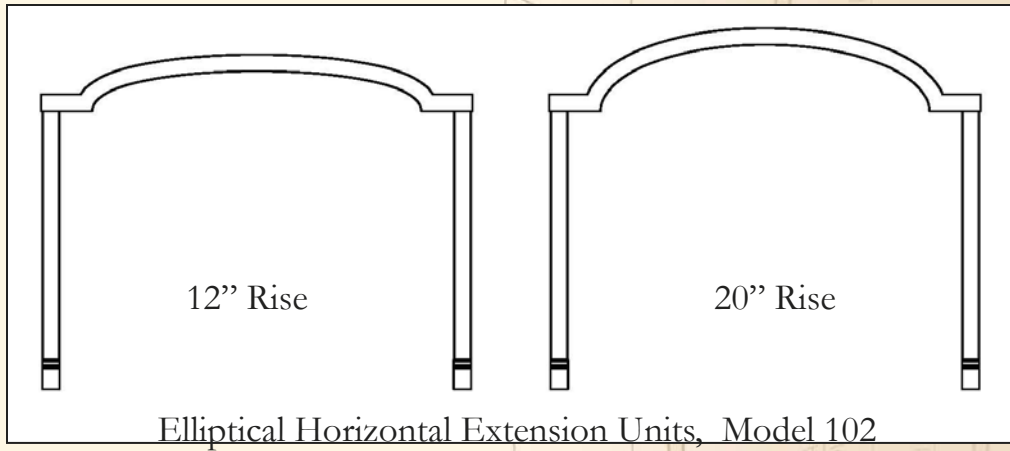
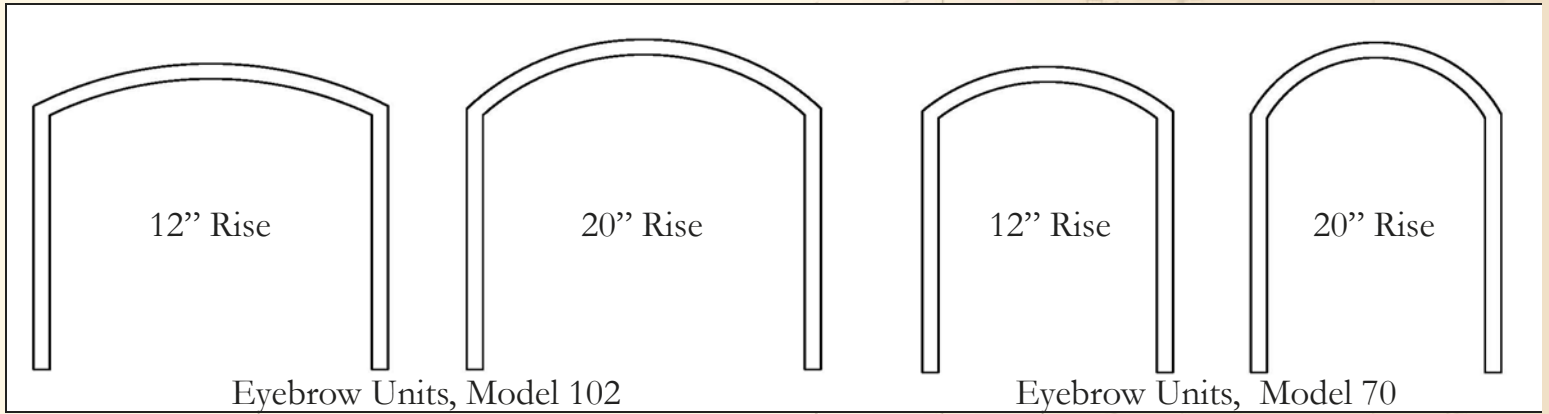

- Right (7a):
- 20" Rise Elliptical
 - #520 Profile
 - Capitals-CA
 - Keystone-KA
 - Recessed Panel-Design 3



CASING & ACCENT OPTIONS

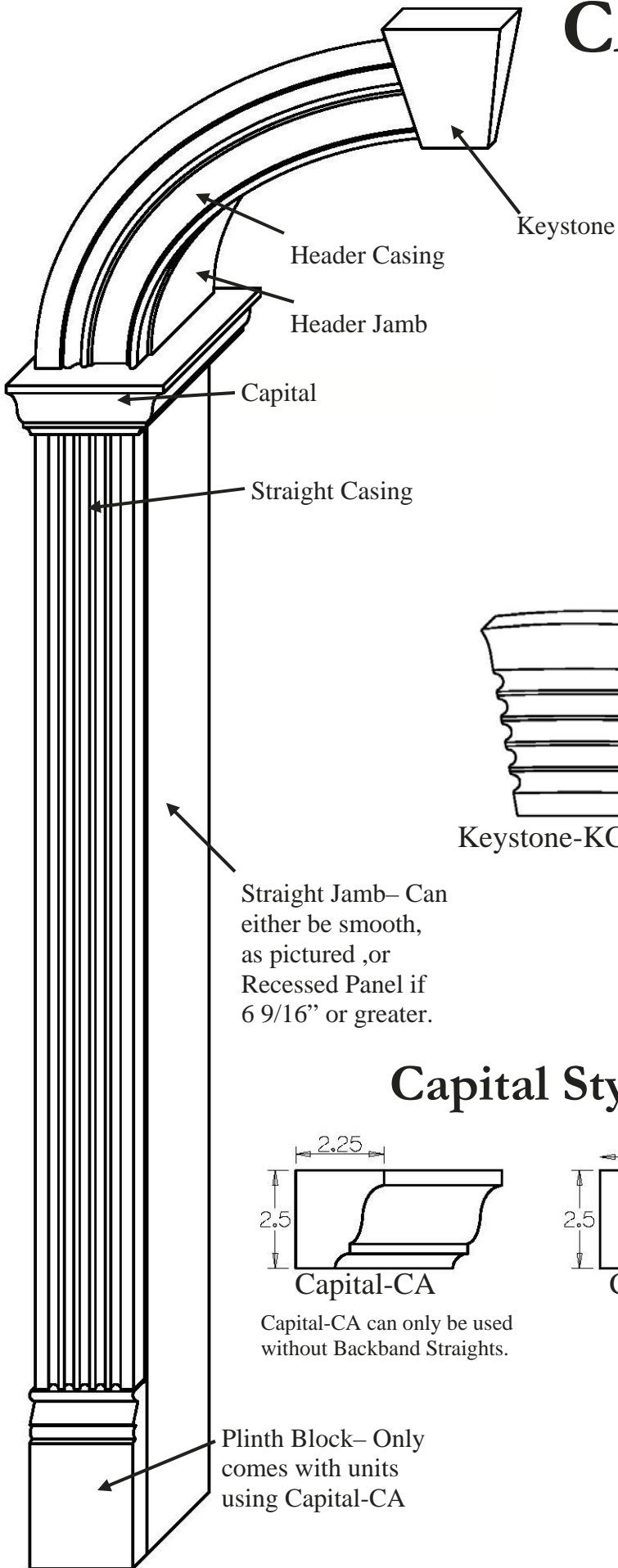

Keystone Styles

Keystones are required on Models 118 and larger.

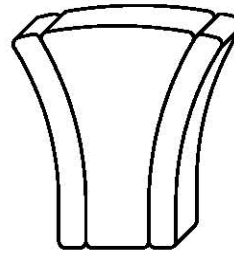

Keystone-KA

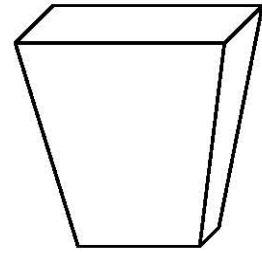

Keystone-KB

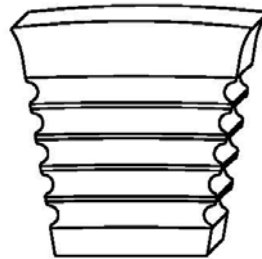

Keystone-KC500

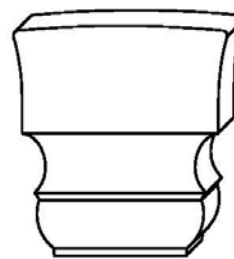

Keystone-KC510

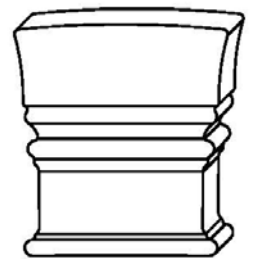

Keystone-KC520



Keystone-KC420



Keystone-KC430

Capital Styles

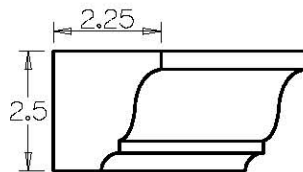

Capital-CA

Capital-CA can only be used without Backband Straights.

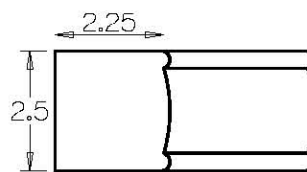

Capital-CB

Plinth Block

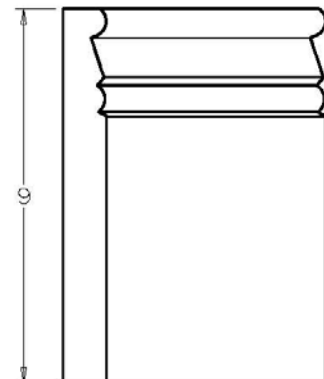

Plinth Blocks are only included with units using Capital-CA.

Plinth Block— Only comes with units using Capital-CA

CASING PROFILES

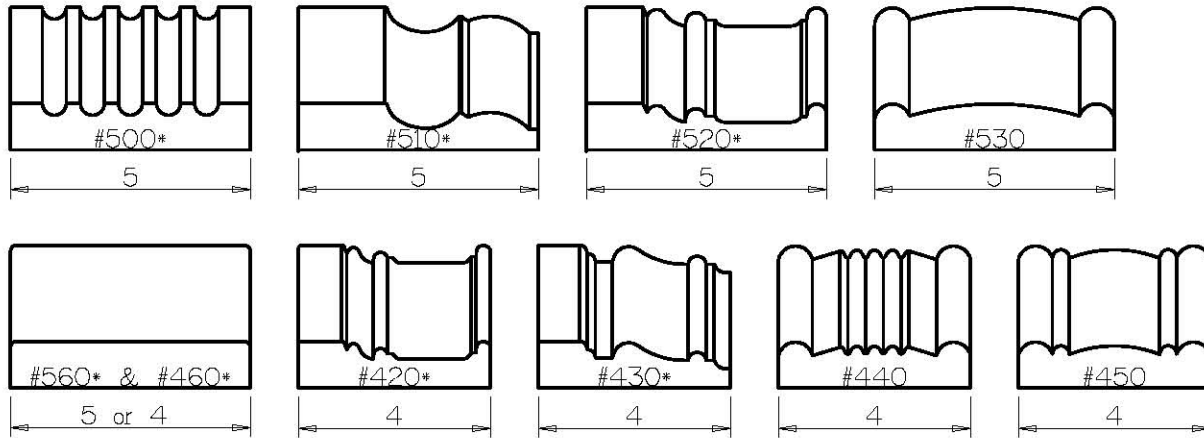

FLUTED PILASTER

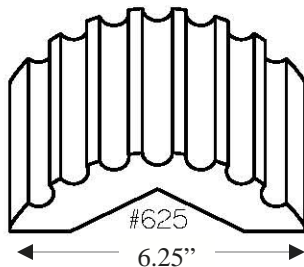

BACKBANDS

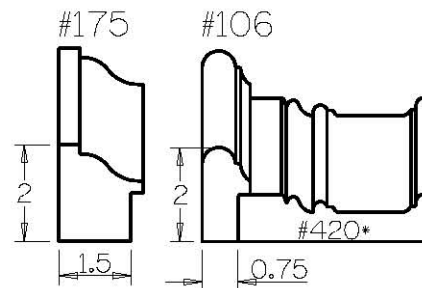

Accent Guidelines

(Also refer to page 37 for Accent Cross Reference)

	Profile Usage	Suggestions \ Comments
Continuous Profile (No Capitals)	All Profiles	Straight casing will be 1" thick, therefore does not come with plinth blocks.
Capital -CA	All Profiles	Straight casing will be 3/4" thick, therefore will come with 4 plinth blocks.
Capital -CB	All Profiles	Use when wanting to use both Capitals and Backband on both the header and straight casing. Straight casing will be 1" thick, therefore do not come with plinth blocks.
Keystones		Required on Model 118 and larger. All Keystones extend a maximum of 1" above header casing.
Keystone-KA	All Casing Profiles	Not Available when using either the #106 or #175 Backband
Keystone-KB	All Profiles	Available for use with all Casing or Backband Profiles.
Keystone-KC	500,510,520,420,430	Available to match #500, 510, 520, 420, 430 Casings and #106 or 175 Backband.
Backband	#500, #510, #520, #560, #460, #420	Backbands are used as an casing accompaniment to add style and substance to the design.
Backband Continuous Profile - #106 or #175	#500, #510, #520, #560, #460, #420	Backband will be on the curved header and straight casing.
Backband with Capital-CA	#500, #510, #520, #560, #460, #420	Backband will only be on curved header. Straight casing will be the standard 4" or 5" casing width (3/4" thick).
Backband with Capital-CB	#500, #510, #520, #560, #460, #420	Capital-CB is recommended when wanting to use both Capitals and Backbands. Backband will be on curved header and straights.
#625 Fluted Pilaster	#510 or #520 casing and either #175 or #106 Backband	#625 Fluted Pilaster is only used as the Vertical Straights. The unit comes with round Capital-CA and 1 1/2" mitered Plinth Blocks.

GRAND OPENINGS BY UDI, INC

RECESSED PANELS

Recessed Panels offer a decorative accent to 6 9/16" and greater wall thickness. Grand Openings offers these panels in five standard design patterns. The standard designs are dependant on the desired number of panels in the straight jamb. The **actual dimension** of the panels is determined, by our design department, on a job to job basis based on Header Height, Wall Thickness and Model Size of the largest unit ordered. Keep in mind when choosing the design pattern, different Header Height openings will have different panel alignment. The Curved Header unit receives an even number of panels approximately the same dimensions as the straight panels. Actual quantity of panels the Curved Header unit varies.

Recessed Panel
Design "2"

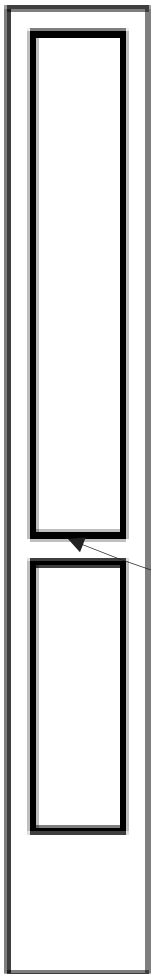

Recessed Panel
Design "3"

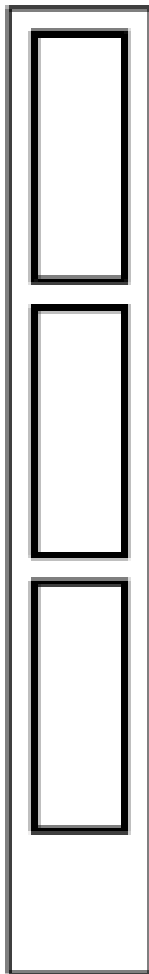

Recessed Panel
Design "4"

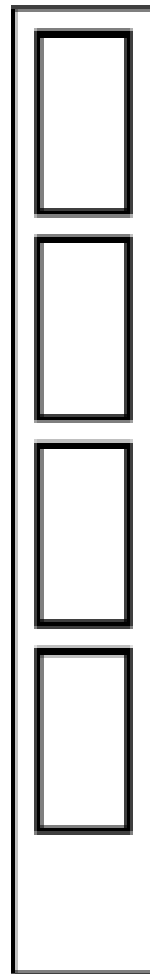

Recessed Panel
Design "5"

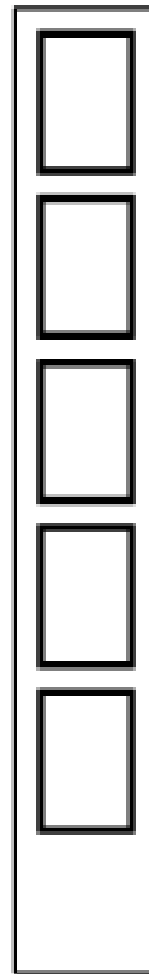

Recessed Panel
Design- "S"*

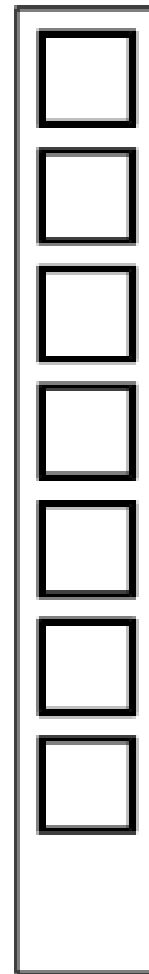

Actual Placement of the two panels may be specified by the customer, using the dimension up from the floor to the center of the rail.

*Actual dimension and quantity of the panels in Design "S" will vary.
Custom Recessed Panel Configurations Available upon request.



Picture 11a-7



Picture 11b

Above Left (11a):

- Elliptical
- 12" Rise
- #510 Profile
- Capitals- CA
- Recessed Panel Custom Design

Above Right (11b):

- 72" Wide Wall Thickness
- Capitals-CA
- Recessed Panel-Custom Design

Right (11c):

- 2x6 Wall
- Capitals-CA
- Recessed Panel-Design 3



Far Right (11d):

- Elliptical
- 12" Rise
- #510 Profile with #106 Backband
- Continuous Profile (No Capitals)
- Recessed Panel- Design- "S"



Picture 11d-7

GRAND OPENINGS BY UDI, INC

FRAMING SPECIFICATIONS

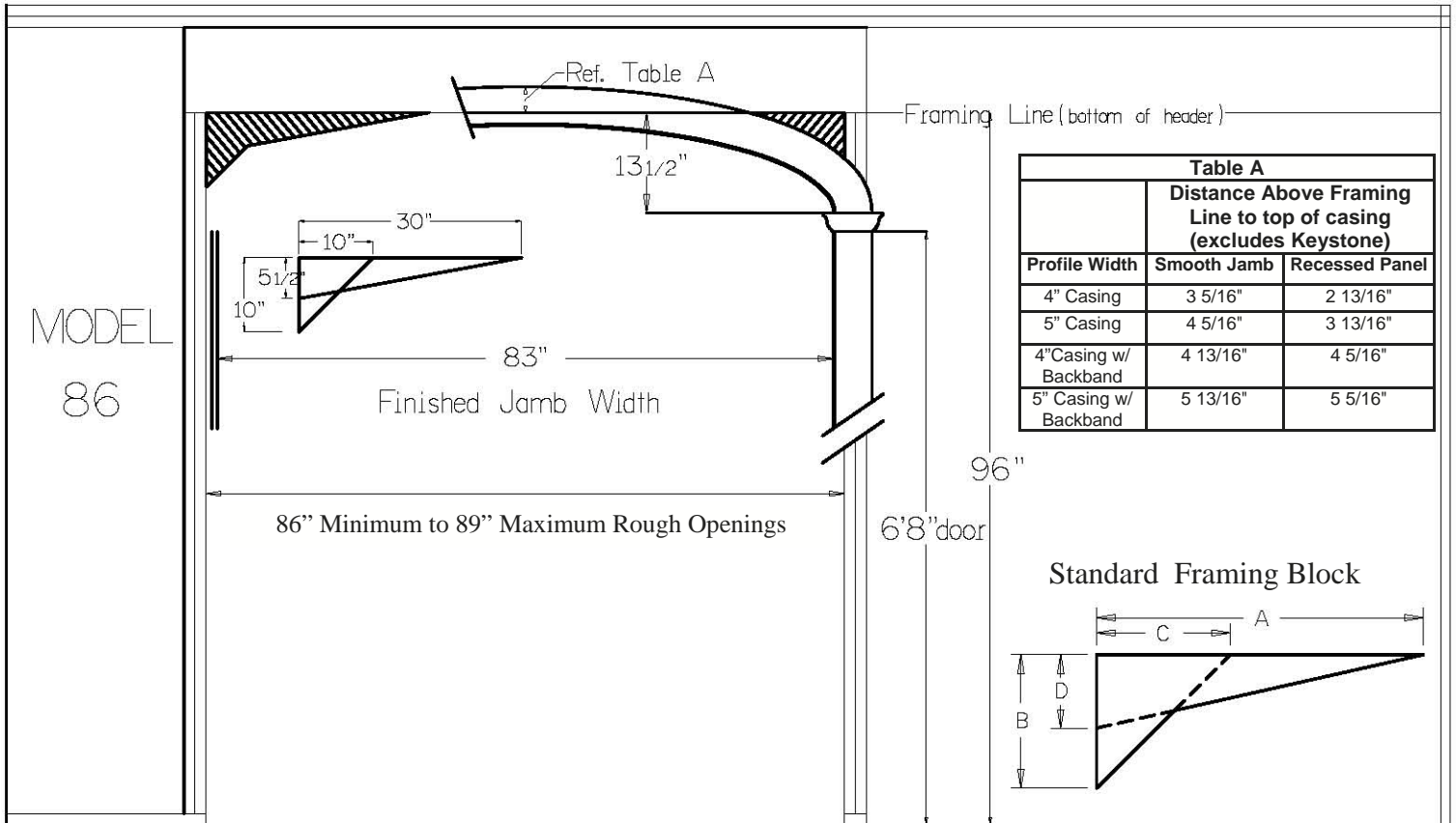

- The top of the capital block on Elliptical and Eyebrow units can be placed at any height by installing header at 13 1/2" above the desired capital height for 12" rise units and 21 1/2" above the desired capital height for 20" rise units.
- When using 104 7/8" studs and 11 3/4" header the capital will be centered at the top of a 6'8" door.
- When using capitals, the rough opening needs to be placed 6 1/4" away from a corner to allow for the capital width. If two openings meet in a corner, rough opening needs to be 8 3/4" away from corner.
- All units have a 3/16" jamb reveal.
- Capital Vertical Height is 2 1/2" and extends 1 1/2" beyond casing.
- Opening Models 118 and Larger come in two pieces and ship with a keystone to cover the seam.
- Individual Framing Instructions for each Model Size are available on our website at <http://www.grandopenings1.com/framing.htm>

Elliptical Framing Instructions use the above diagram and chart from following page.

Eyebrow Units see page 20-21, Halfround Units see page 22

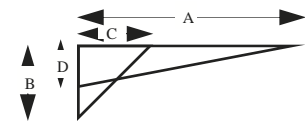

12" Rise Elliptical Design Framing Specifications (All Dimensions in Inches)											
			Outside Finished Width					Dimensions of Rough-In Framing Blocks			
Opening Model #	Rough Opening Width (Min - Max)	Finished Jamb Width	4" Casing No Capitals	4" Casing w/ Backband or Capitals	5" Casing No Capitals	5" Casing w/ Backband or Capitals	#625 Pilaster	"A"	"B"	"C"	"D"
30,12" rise	30 - 33	27	35 3/8	38 3/8	37 3/8	40 3/8	42 7/8	12	8 1/2	8 1/2	5 1/2
32,12" rise	32 - 35	29	37 3/8	40 3/8	39 3/8	42 3/8	44 7/8	12	8 1/2	8 1/2	5 1/2
34,12" rise	34 - 37	31	39 3/8	42 3/8	41 3/8	44 3/8	46 7/8	12	8 1/2	8 1/2	5 1/2
36,12" rise	36 - 39	33	41 3/8	44 3/8	43 3/8	46 3/8	48 7/8	14	8 1/2	8 1/2	5 1/2
38,12" rise	38 - 41	35	43 3/8	46 3/8	45 3/8	48 3/8	50 7/8	14	8 1/2	8 1/2	5 1/2
40,12" rise	40 - 43	37	45 3/8	48 3/8	47 3/8	50 3/8	52 7/8	15	9	9 1/2	6
42,12" rise	42 - 45	39	47 3/8	50 3/8	49 3/8	52 3/8	54 7/8	15	9	9 1/2	6
44,12" rise	44 - 47	41	49 3/8	52 3/8	51 3/8	54 3/8	56 7/8	16	9 1/2	9 1/2	6
46,12" rise	46 - 49	43	51 3/8	54 3/8	53 3/8	56 3/8	58 7/8	16	9 1/2	9 1/2	6
48,12" rise	48 - 51	45	53 3/8	56 3/8	55 3/8	58 3/8	61 7/8	17	9 1/2	9 1/2	6
50,12" rise	50 - 53	47	55 3/8	58 3/8	57 3/8	60 3/8	62 7/8	17	9 1/2	9 1/2	6
54,12" rise	54 - 57	51	59 3/8	62 3/8	61 3/8	64 3/8	66 7/8	19	9 1/2	9 1/2	6
58,12" rise	58 - 61	55	63 3/8	66 3/8	65 3/8	68 3/8	70 7/8	22	10	10	6
62,12" rise	62 - 65	59	67 3/8	70 3/8	69 3/8	72 3/8	74 7/8	22	10	10	6
66,12" rise	66 - 69	63	71 3/8	74 3/8	73 3/8	76 3/8	78 7/8	24	10	10	5 1/2
70,12" rise	70 - 73	67	75 3/8	78 3/8	77 3/8	80 3/8	82 7/8	24	10	10	5 1/2
72,12" rise	72 - 75	69	77 3/8	80 3/8	79 3/8	82 3/8	84 7/8	25	10 1/2	10 1/2	5 1/2
74,12" rise	74 - 77	71	79 3/8	82 3/8	81 3/8	84 3/8	86 7/8	27	10 1/2	10 1/2	5 1/2
78,12" rise	78 - 81	75	83 3/8	86 3/8	85 3/8	88 3/8	90 7/8	27	10 1/2	10 1/2	5 1/2
82,12" rise	82 - 85	79	87 3/8	90 3/8	89 3/8	92 3/8	94 7/8	30	10 1/2	10 1/2	5 1/2
86,12" rise	86 - 89	83	91 3/8	94 3/8	93 3/8	96 3/8	98 7/8	30	10 1/2	10 1/2	5 1/2
90,12" rise	90 - 93	87	95 3/8	98 3/8	97 3/8	100 3/8	102 7/8	33	10 1/2	10 1/2	5 1/2
94,12" rise	94 - 97	91	99 3/8	102 3/8	101 3/8	104 3/8	106 7/8	33	10 1/2	10 1/2	5 1/2
98,12" rise	98 - 101	95	103 3/8	106 3/8	105 3/8	108 3/8	110 7/8	35	10 1/2	10 1/2	5 1/2
102,12" rise	102 - 105	99	107 3/8	110 3/8	109 3/8	112 3/8	114 7/8	35	10 1/2	10 1/2	5 1/2
106,12" rise	106 - 109	103	111 3/8	114 3/8	113 3/8	116 3/8	118 7/8	35	10 1/2	10 1/2	5 1/2
110,12" rise	110 - 113	107	115 3/8	118 3/8	117 3/8	120 3/8	122 7/8	35	10 1/2	10 1/2	5 1/2
114,12" rise	114 - 117	111	119 3/8	122 3/8	121 3/8	124 3/8	126 7/8	36	10 1/2	10 1/2	5 1/2
118*,12" rise	118 - 121	115	123 3/8	126 3/8	125 3/8	128 3/8	130 7/8	36	10 1/2	10 1/2	5 1/2
122*,12" rise	122 - 125	119	127 3/8	130 3/8	129 3/8	132 3/8	134 7/8	41	10 1/4	10 1/4	6
126*,12" rise	126 - 129	123	131 3/8	134 3/8	133 3/8	136 3/8	138 7/8	41	10 1/4	10 1/4	6
130*,12" rise	130 - 133	127	135 3/8	138 3/8	137 3/8	140 3/8	142 7/8	43	10 1/4	10 1/4	6
134*,12" rise	134 - 137	131	139 3/8	142 3/8	141 3/8	144 3/8	146 7/8	43	10 1/4	10 1/4	6
138*,12" rise	138 - 141	135	143 3/8	146 3/8	145 3/8	148 3/8	150 7/8	46	10 1/4	10 1/4	6
142*,12" rise	142 - 145	139	147 3/8	150 3/8	149 3/8	152 3/8	154 7/8	46	10 1/4	10 1/4	6
146*,12" rise	146 - 149	143	151 3/8	154 3/8	153 3/8	156 3/8	158 7/8	49	10 1/4	10 1/4	5 3/4
150*,12" rise	150 - 153	147	155 3/8	158 3/8	157 3/8	160 3/8	162 7/8	49	10 1/4	10 1/4	5 3/4
154*,12" rise	154 - 157	151	159 3/8	162 3/8	161 3/8	164 3/8	166 7/8	51	10 1/4	10 1/4	5 3/4
158*,12" rise	158 - 161	155	163 3/8	166 3/8	165 3/8	168 3/8	170 7/8	51	10 1/4	10 1/4	5 3/4
162*,12" rise	162 - 165	159	167 3/8	170 3/8	169 3/8	172 3/8	174 7/8	53	10 1/4	10 1/4	5 3/4
166*,12" rise	166 - 169	163	171 3/8	174 3/8	173 3/8	176 3/8	178 7/8	53	10 1/4	10 1/4	5 3/4
170*,12" rise	170 - 173	167	175 3/8	178 3/8	177 3/8	180 3/8	182 7/8	55	10 1/4	10 1/4	5 3/4

*Assembled in two pieces with a Keystone and Moulding Key Extension to cover seam.
All dimensions assume a 1/4" tolerance.

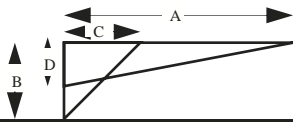

Grand Openings By UDI, Inc
(479) 925-1318

20" Rise Elliptical Design Framing Specifications (All Dimensions in Inches)

Opening Model #	Rough Opening Width (Min - Max)	Finished Jamb Width	Outside Finished Width					Dimensions of Rough-In Framing Blocks			
			4"Casing No Capitals	4"Casing w/ Backband or Capitals	5"Casing No Capitals	5"Casing w/ Backband or Capitals	#625 Pilaster	"A"	"B"	"C"	"D"
30, 20" rise	30 - 33	27	34 3/8	37 3/8	36 3/8	39 3/8	41 7/8	11	11	6	6
32, 20" rise	32 - 35	29	37 3/8	40 3/8	39 3/8	42 3/8	44 7/8	12	12	7	7
34, 20" rise	34 - 37	31	39 3/8	42 3/8	41 3/8	44 3/8	46 7/8	13	13	7	7
36, 20" rise	36 - 39	33	41 3/8	44 3/8	43 3/8	46 3/8	48 7/8	14	14	7	7
38, 20" rise	38 - 41	35	43 3/8	46 3/8	45 3/8	48 3/8	50 7/8	15	15	7	7
40, 20" rise	40 - 43	37	45 3/8	48 3/8	47 3/8	50 3/8	52 7/8	16	16	7	7
42, 20" rise	42 - 45	39	47 3/8	50 3/8	49 3/8	52 3/8	54 7/8	16	16	8	8
44, 20" rise	44 - 47	41	49 3/8	52 3/8	51 3/8	54 3/8	56 7/8	14	17	7 1/2	11
46, 20" rise	46 - 49	43	51 3/8	54 3/8	53 3/8	56 3/8	58 7/8	14	17	7 1/2	11
48, 20" rise	48 - 51	45	53 3/8	56 3/8	55 3/8	58 3/8	60 7/8	15	17	7 1/2	11
50, 20" rise	50 - 53	47	55 3/8	58 3/8	57 3/8	60 3/8	62 7/8	15	17 1/2	7 1/2	12 1/2
54, 20" rise	54 - 57	51	59 3/8	62 3/8	61 3/8	64 3/8	66 7/8	16	17 1/2	8	12 1/2
58, 20" rise	58 - 61	55	63 3/8	66 3/8	65 3/8	68 3/8	70 7/8	17	17 1/2	8	12 1/2
62, 20" rise	62 - 65	59	67 3/8	70 3/8	69 3/8	72 3/8	74 7/8	18	17 1/2	8	12 1/2
66, 20" rise	66 - 69	63	71 3/8	74 3/8	73 3/8	76 3/8	78 7/8	19	17 1/2	9	12 1/2
70, 20" rise	70 - 73	67	75 3/8	78 3/8	77 3/8	80 3/8	82 7/8	20	17 1/2	10	12 1/2
72, 20" rise	72 - 75	69	77 3/8	80 3/8	79 3/8	82 3/8	84 7/8	21	17 1/2	10	12 1/2
74, 20" rise	74 - 77	71	79 3/8	82 3/8	81 3/8	84 3/8	86 7/8	21	17 1/2	10	12 1/2
78, 20" rise	78 - 81	75	83 3/8	86 3/8	85 3/8	88 3/8	90 7/8	22	17 1/2	11	12 1/2
82, 20" rise	82 - 85	79	87 3/8	90 3/8	89 3/8	92 3/8	94 7/8	23	17 1/2	12	12 1/2
86, 20" rise	86 - 89	83	91 3/8	94 3/8	93 3/8	96 3/8	98 7/8	25	18	12	12 1/2
90, 20" rise	90 - 93	87	95 3/8	98 3/8	97 3/8	100 3/8	102 7/8	26	18	12	12 1/2
94, 20" rise	94 - 97	91	99 3/8	102 3/8	101 3/8	104 3/8	106 7/8	27	18	13	12 1/2
98, 20" rise	98 - 101	95	103 3/8	106 3/8	105 3/8	108 3/8	110 7/8	28	18	13	12 1/2
102, 20" rise	102 - 105	99	107 3/8	110 3/8	109 3/8	112 3/8	114 7/8	29	18	13	12 1/2
106, 20" rise	106 - 109	103	111 3/8	114 3/8	113 3/8	116 3/8	118 7/8	30	18	13	12 1/2
110, 20" rise	110 - 113	107	115 3/8	118 3/8	117 3/8	120 3/8	122 7/8	31	18	13	12 1/2
114, 20" rise	114 - 117	111	119 3/8	122 3/8	121 3/8	124 3/8	126 7/8	33	18 1/2	13 1/2	12 1/2
118*, 20" rise	118 - 121	115	123 3/8	126 3/8	125 3/8	128 3/8	130 7/8	33	18 1/2	13 1/2	12 1/2
122*, 20" rise	122 - 125	119	127 3/8	130 3/8	129 3/8	132 3/8	134 7/8	35	18 1/2	14 1/2	12 1/2
126*, 20" rise	126 - 129	123	131 3/8	134 3/8	133 3/8	136 3/8	138 7/8	35	18 1/2	14 1/2	12 1/2
130*, 20" rise	130 - 133	127	135 3/8	138 3/8	137 3/8	140 3/8	142 7/8	37	18 1/2	15	12 1/2
134*, 20" rise	134 - 137	131	139 3/8	142 3/8	141 3/8	144 3/8	146 7/8	37	18 1/2	15	12 1/2
138*, 20" rise	138 - 141	135	143 3/8	146 3/8	145 3/8	148 3/8	150 7/8	39	18 1/2	15	12 1/2
142*, 20" rise	142 - 145	139	147 3/8	150 3/8	149 3/8	152 3/8	154 7/8	39	18 1/2	15	12 1/2
146*, 20" rise	146 - 149	143	151 3/8	154 3/8	153 3/8	156 3/8	158 7/8	41	18 1/2	16	12 1/2
150*, 20" rise	150 - 153	147	155 3/8	158 3/8	157 3/8	160 3/8	162 7/8	41	18 1/2	16	12 1/2
154*, 20" rise	154 - 157	151	159 3/8	162 3/8	161 3/8	164 3/8	166 7/8	43	18 1/2	17	12 1/2
158*, 20" rise	158 - 161	155	163 3/8	166 3/8	165 3/8	168 3/8	170 7/8	43	18 1/2	17	12 1/2
162*, 20" rise	162 - 165	159	167 3/8	170 3/8	169 3/8	172 3/8	174 7/8	46	18 1/2	18	12 1/2
166*, 20" rise	166 - 169	163	171 3/8	174 3/8	173 3/8	176 3/8	178 7/8	46	18 1/2	18	12 1/2
170*, 20" rise	170 - 173	167	175 3/8	178 3/8	177 3/8	180 3/8	182 7/8	46	18 1/2	18	12 1/2

20" Rise units are only recommended for 10' ceilings or greater. See Page 6-7 For more info.

*Assembled in two pieces with a Keystone and Moulding Key Extension to cover seam.

All dimensions assume a 1/4" tolerance

12" Rise Eyebrow Design Framing Specifications (All Dimensions in Inches)

Opening Model #	Rough Opening Width (Min - Max)	Finished Jamb Width	Outside Finished Width					Dimensions of Rough-In Blocks			
			4" Casing No Capitals	4" Casing w/ Backband or Capitals	5" Casing No Capitals	5" Casing w/ Backband or Capitals	#625 Pilaster	"A"	"B"	"C"	"D"
30,12" rise	30 - 33	27	35 3/8	38 3/8	37 3/8	40 3/8	42 7/8	12	8 1/2	8 1/2	5 1/2
32,12" rise	32 - 35	29	37 3/8	40 3/8	39 3/8	42 3/8	44 7/8	12	9	9	5 1/2
34,12" rise	34 - 37	31	39 3/8	42 3/8	41 3/8	44 3/8	46 7/8	12	9	9	5 1/2
36,12" rise	36 - 39	33	41 3/8	44 3/8	43 3/8	46 3/8	48 7/8	14	10	10	5 1/2
38,12" rise	38 - 41	35	43 3/8	46 3/8	45 3/8	48 3/8	50 7/8	14	10	10	5 1/2
40,12" rise	40 - 43	37	45 3/8	48 3/8	47 3/8	50 3/8	52 7/8	15	10 1/2	10 1/2	7
42,12" rise	42 - 45	39	47 3/8	50 3/8	49 3/8	52 3/8	54 7/8	15	11	11	7
44,12" rise	44 - 47	41	49 3/8	52 3/8	51 3/8	54 3/8	56 7/8	16	11	11	7
46,12" rise	46 - 49	43	51 3/8	54 3/8	53 3/8	56 3/8	58 7/8	16	11 1/2	11 1/2	7
48,12" rise	48 - 51	51	53 3/8	56 3/8	55 3/8	58 3/8	60 7/8	17	11 1/2	11 1/2	8
50,12" rise	50 - 53	47	55 3/8	58 3/8	57 3/8	60 3/8	62 7/8	17	12	11 1/2	8
54,12" rise	54 - 57	51	59 3/8	62 3/8	61 3/8	64 3/8	66 7/8	20	12	12	8
58,12" rise	58 - 61	55	63 3/8	66 3/8	65 3/8	68 3/8	70 7/8	20	12	12	9
62,12" rise	62 - 65	59	67 3/8	70 3/8	69 3/8	72 3/8	74 7/8	20	12	12	9
66,12" rise	66 - 69	63	71 3/8	74 3/8	73 3/8	76 3/8	78 7/8	20	11 1/2	Only Requires "A" and "B" Framing Dimensions	
70,12" rise	70 - 73	67	75 3/8	78 3/8	77 3/8	80 3/8	82 7/8	21	11 1/2		
72,12" rise	72 - 75	69	77 3/8	80 3/8	79 3/8	82 3/8	84 7/8	22	11 1/2		
74,12" rise	74 - 77	71	79 3/8	82 3/8	81 3/8	84 3/8	86 7/8	23	11 1/2		
78,12" rise	78 - 81	75	83 3/8	86 3/8	85 3/8	88 3/8	90 7/8	24	11 1/2		
82,12" rise	82 - 85	79	87 3/8	90 3/8	89 3/8	92 3/8	94 7/8	25	11 1/2		
86,12" rise	86 - 89	83	91 3/8	94 3/8	93 3/8	96 3/8	98 7/8	26	11 1/2		
90,12" rise	90 - 93	87	95 3/8	98 3/8	97 3/8	100 3/8	102 7/8	29	11		
94,12" rise	94 - 97	91	99 3/8	102 3/8	101 3/8	104 3/8	106 7/8	30	11		
98,12" rise	98 - 101	95	103 3/8	106 3/8	105 3/8	108 3/8	110 7/8	31	11		
102,12" rise	102 - 105	99	107 3/8	110 3/8	109 3/8	112 3/8	114 7/8	32	11		
106,12" rise	106 - 109	103	111 3/8	114 3/8	113 3/8	116 3/8	118 7/8	34	11		
110,12" rise	110 - 113	107	115 3/8	118 3/8	117 3/8	120 3/8	122 7/8	35	11		
114,12" rise	114 - 117	111	119 3/8	122 3/8	121 3/8	124 3/8	126 7/8	36	11		
118*,12" rise	118 - 121	115	123 3/8	126 3/8	125 3/8	128 3/8	130 7/8	37	11		
122*,12" rise	122 - 125	119	127 3/8	130 3/8	129 3/8	132 3/8	134 7/8	38	11		
126*,12" rise	126 - 129	123	131 3/8	134 3/8	133 3/8	136 3/8	138 7/8	40	11		
130*,12" rise	130 - 133	127	135 3/8	138 3/8	137 3/8	140 3/8	142 7/8	41	11		
134*,12" rise	134 - 137	131	139 3/8	142 3/8	141 3/8	144 3/8	146 7/8	43	11		
138*,12" rise	138 - 141	135	143 3/8	146 3/8	145 3/8	148 3/8	150 7/8	44	11		
142*,12" rise	142 - 145	139	147 3/8	150 3/8	149 3/8	152 3/8	154 7/8	45	11		
146*,12" rise	146 - 149	143	151 3/8	154 3/8	153 3/8	156 3/8	158 7/8	46	11		
150*,12" rise	150 - 153	147	155 3/8	158 3/8	157 3/8	160 3/8	162 7/8	48	11		
154*,12" rise	154 - 157	151	159 3/8	162 3/8	161 3/8	164 3/8	166 7/8	49	11		
158*,12" rise	158 - 161	155	163 3/8	166 3/8	165 3/8	168 3/8	170 7/8	50	11		
162*,12" rise	162 - 165	159	167 3/8	170 3/8	169 3/8	172 3/8	174 7/8	51	11		
166*,12" rise	166 - 169	163	171 3/8	174 3/8	173 3/8	176 3/8	178 7/8	52	11		
170*,12" rise	170 - 173	167	175 3/8	178 3/8	177 3/8	180 3/8	182 7/8	53	11		

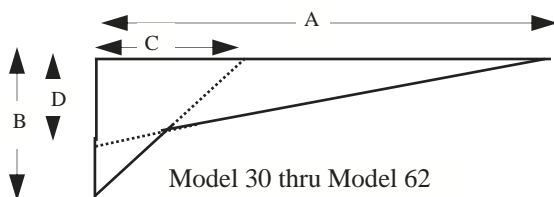

Framing Block

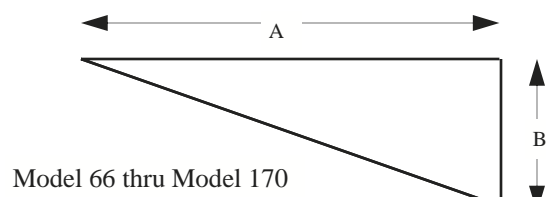

*Assembled in two pieces with a Keystone and Moulding Key Extension to cover seam

20" Rise Eyebrow Design Framing Specifications (All Dimensions in Inches)

Opening Model #	Rough Opening Width (Min - Max)	Finished Jamb Width	Outside Finished Width					Dimensions of Rough-In Blocks			
			4" Casing No Capitals	4" Casing w/ Backband or Capitals	5" Casing No Capitals	5" Casing w/ Backband or Capitals	#625 Pilaster	"A"	"B"	"C"	"D"
30, 20" rise	30 - 33	27	35 3/8	38 3/8	37 3/8	40 3/8	42 7/8	11	11	6	6
32, 20" rise	32 - 35	29	37 3/8	40 3/8	39 3/8	42 3/8	44 7/8	12	12	7	7
34, 20" rise	34 - 37	31	39 3/8	42 3/8	41 3/8	44 3/8	46 7/8	13	13	7	7
36, 20" rise	36 - 39	33	41 3/8	44 3/8	43 3/8	46 3/8	48 7/8	14	14	7	7
38, 20" rise	38 - 41	35	43 3/8	46 3/8	45 3/8	48 3/8	50 7/8	15	15	7	7
40, 20" rise	40 - 43	37	45 3/8	48 3/8	47 3/8	50 3/8	52 7/8	16	16	7	7
42, 20" rise	42 - 45	39	47 3/8	50 3/8	49 3/8	52 3/8	54 7/8	16	16	8	8
44, 20" rise	44 - 47	41	49 3/8	52 3/8	51 3/8	54 3/8	56 7/8	14	17	7 1/2	11
46, 20" rise	46 - 49	43	51 3/8	54 3/8	53 3/8	56 3/8	58 7/8	15	17	8	11
48, 20" rise	48 - 51	45	53 3/8	56 3/8	55 3/8	58 3/8	60 7/8	16	17	8 1/2	11
50, 20" rise	50 - 53	47	55 3/8	58 3/8	57 3/8	60 3/8	62 7/8	17	18	9	11
54, 20" rise	54 - 57	51	59 3/8	62 3/8	61 3/8	64 3/8	66 7/8	19	18	11	11
58, 20" rise	58 - 61	55	63 3/8	66 3/8	65 3/8	68 3/8	70 7/8	21	19	12	12
62, 20" rise	62 - 65	59	67 3/8	70 3/8	69 3/8	72 3/8	74 7/8	22	19	14	12
66, 20" rise	66 - 69	63	71 3/8	74 3/8	73 3/8	76 3/8	78 7/8	24	19	16	12
70, 20" rise	70 - 73	67	75 3/8	78 3/8	77 3/8	80 3/8	82 7/8	24	19	16	12
72, 20" rise	72 - 75	69	77 3/8	80 3/8	79 3/8	82 3/8	84 7/8	26	19	17	12
74, 20" rise	74 - 77	71	79 3/8	82 3/8	81 3/8	84 3/8	86 7/8	28	19	19	12
78, 20" rise	78 - 81	75	83 3/8	86 3/8	85 3/8	88 3/8	90 7/8	28	19	19	12
82, 20" rise	82 - 85	79	87 3/8	90 3/8	89 3/8	92 3/8	94 7/8	31	19	22	12 1/2
86, 20" rise	86 - 89	83	91 3/8	94 3/8	93 3/8	96 3/8	98 7/8	31	19	22	12 1/2
90, 20" rise	90 - 93	87	95 3/8	98 3/8	97 3/8	100 3/8	102 7/8	34	19	25	13
94, 20" rise	94 - 97	91	99 3/8	102 3/8	101 3/8	104 3/8	106 7/8	34	19	25	13
98, 20" rise	98 - 101	95	103 3/8	106 3/8	105 3/8	108 3/8	110 7/8	36	19 1/2	26	13
102, 20" rise	102 - 105	99	107 3/8	110 3/8	109 3/8	112 3/8	114 7/8	36	19 1/2	26	13
106, 20" rise	106 - 109	103	111 3/8	114 3/8	113 3/8	116 3/8	118 7/8	39	19 1/2	28	14
110, 20" rise	110 - 113	107	115 3/8	118 3/8	117 3/8	120 3/8	122 7/8	39	19 1/2	28	14
114, 20" rise	114 - 117	111	119 3/8	122 3/8	121 3/8	124 3/8	126 7/8	42	20	30	14
118*, 20" rise	118 - 121	115	123 3/8	126 3/8	125 3/8	128 3/8	130 7/8	42	20	30	14
122*, 20" rise	122 - 125	119	127 3/8	130 3/8	129 3/8	132 3/8	134 7/8	45	20	31	14
126*, 20" rise	126 - 129	123	131 3/8	134 3/8	133 3/8	136 3/8	138 7/8	45	20	31	14
130*, 20" rise	130 - 133	127	135 3/8	138 3/8	137 3/8	140 3/8	142 7/8	48	20	33	14
134*, 20" rise	134 - 137	131	139 3/8	142 3/8	141 3/8	144 3/8	146 7/8	48	20	33	14
138*, 20" rise	138 - 141	135	143 3/8	146 3/8	145 3/8	148 3/8	150 7/8	51	20	36	14
142*, 20" rise	142 - 145	139	147 3/8	150 3/8	149 3/8	152 3/8	154 7/8	51	20	36	14
146*, 20" rise	146 - 149	143	151 3/8	154 3/8	153 3/8	156 3/8	158 7/8	54	20	39	14
150*, 20" rise	150 - 153	147	155 3/8	158 3/8	157 3/8	160 3/8	162 7/8	54	20	39	14
154*, 20" rise	154 - 157	151	159 3/8	162 3/8	161 3/8	164 3/8	166 7/8	54	20	39	14
158*, 20" rise	158 - 161	155	163 3/8	166 3/8	165 3/8	168 3/8	170 7/8	60	20	43	14
162*, 20" rise	162 - 165	159	167 3/8	170 3/8	169 3/8	172 3/8	174 7/8	60	20	43	14
166*, 20" rise	166 - 169	163	171 3/8	174 3/8	173 3/8	176 3/8	178 7/8	60	20	43	14
170*, 20" rise	170 - 173	167	175 3/8	178 3/8	177 3/8	180 3/8	182 7/8	60	20	43	14

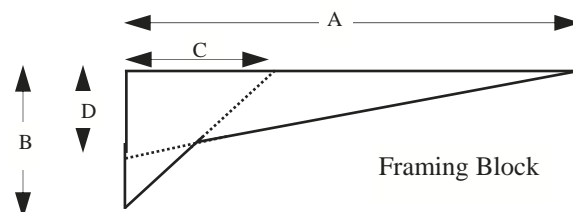

*Assembled in two pieces with a Keystone and Moulding Key Extension to cover seam

GRAND OPENINGS BY UDI, INC

HALFROUND DESIGN

The Halfround Design is a true radius arch. Many customers choose this design for narrow openings, even when using Elliptical or Eyebrow units elsewhere in the application.

Halfround Framing Specifications

Opening Model #	Rough Opening Width (Min - Max)	Finished Jamb Width	Outside Finished Width					Dimensions of Rough-In Blocks			
			4" Casing No Capitals	4" Casing w/ Backband or Capitals	5" Casing No Capitals	5" Casing w/ Backband or Capitals	#625 Pilaster	"A"	"B"	"C"	"D"
30	30 - 31 1/2	27	34 3/8	37 3/8	36 3/8	39 3/8	41 7/8	11	11	6	6
32	32 - 33 1/2	29	37 3/8	40 3/8	39 3/8	42 3/8	44 7/8	12	12	7	7
34	34 - 35 1/2	31	39 3/8	42 3/8	41 3/8	44 3/8	46 7/8	13	13	7	7
36	36 - 37 1/2	33	41 3/8	44 3/8	43 3/8	46 3/8	48 7/8	14	14	7	7
38	38 - 39 1/2	35	43 3/8	46 3/8	45 3/8	48 3/8	50 7/8	15	15	7	7
40	40 - 41 1/2	37	45 3/8	48 3/8	47 3/8	50 3/8	52 7/8	16	16	7	7
42	42 - 43 1/2	39	47 3/8	50 3/8	49 3/8	52 3/8	54 7/8	16	16	8	8
44	44 - 45 1/2	41	49 3/8	52 3/8	51 3/8	54 3/8	56 7/8	17	17	8	8
46	46 - 47 1/2	43	51 3/8	54 3/8	53 3/8	56 3/8	58 7/8	18	18	8	8
48	48 - 49 1/2	45	53 3/8	56 3/8	55 3/8	58 3/8	60 7/8	18	18	9	9
50	50 - 51 1/2	47	55 3/8	58 3/8	57 3/8	60 3/8	62 7/8	20	20	9	9
54	54 - 55 1/2	51	59 3/8	62 3/8	61 3/8	64 3/8	66 7/8	21	21	10	10
58	58 - 59 1/2	55	63 3/8	66 3/8	65 3/8	68 3/8	70 7/8	22	22	12	12
62	62 - 63 1/2	59	67 3/8	70 3/8	69 3/8	72 3/8	74 7/8	23	23	13	13
66	66 - 67 1/2	63	71 3/8	74 3/8	73 3/8	76 3/8	78 7/8	25	25	13	13
70	70 - 71 1/2	67	75 3/8	78 3/8	77 3/8	80 3/8	82 7/8	25	25	16	16
72	72 - 73 1/2	69	77 3/8	80 3/8	79 3/8	82 3/8	84 7/8	25	25	17	17
74	74 - 75 1/2	71	79 3/8	82 3/8	81 3/8	84 3/8	86 7/8	26	26	17	17



* All Dimensions in Inches

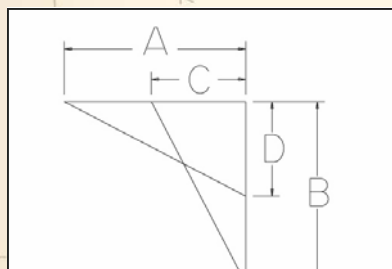

Left (Picture 22a):

- #510 Profile
- Capital—CA
- 42" Wide Recessed Panels—Custom Design
- Stain Grade Poplar

Right (Picture 22b):

- #430 Profile
- Continuous Profile (No Capitals)



Picture 22b-7

GRAND OPENINGS BY UDI, INC

HORIZONTAL EXTENSION FRAMING

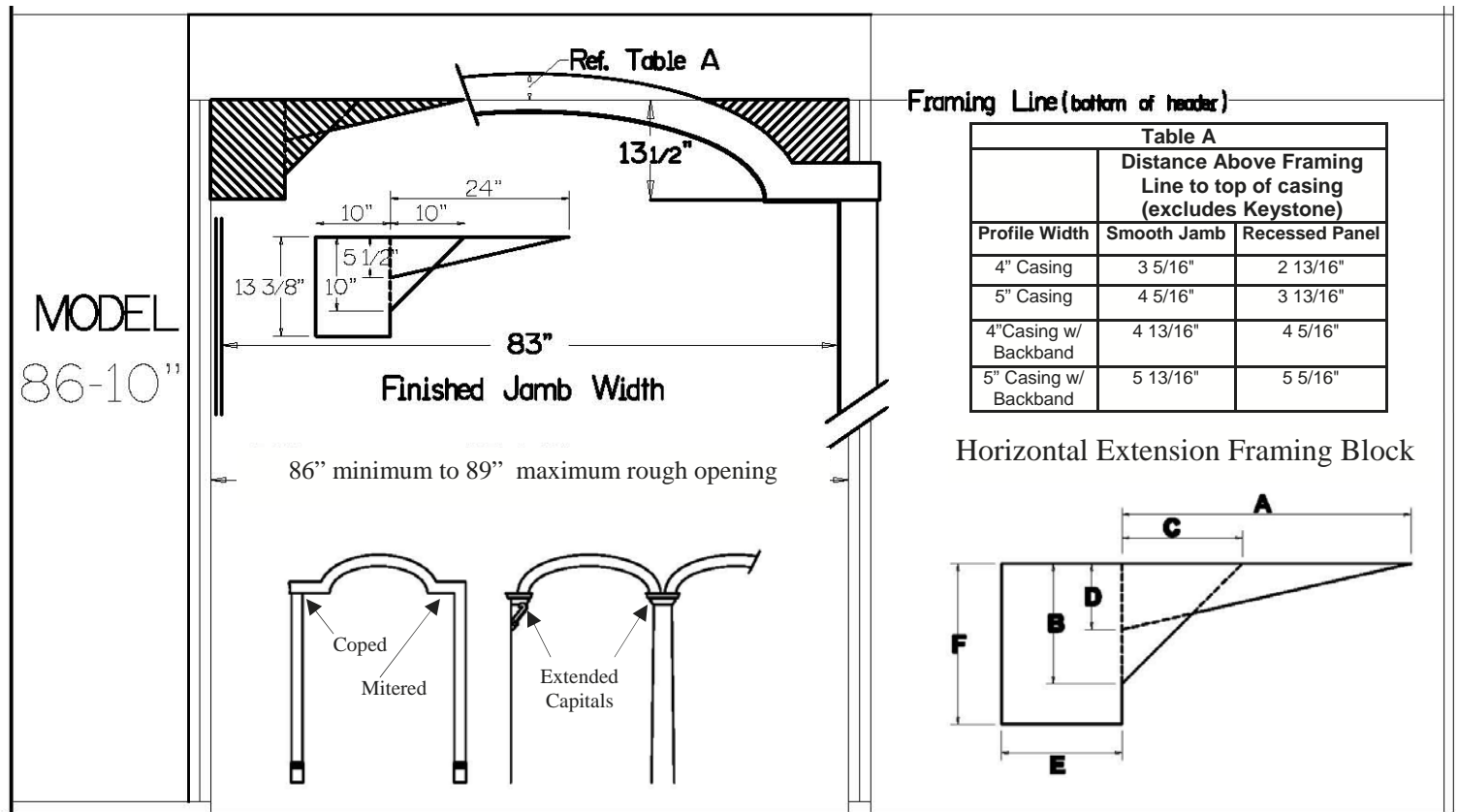

- Unit Horizontal extensions can be either 2", 8", 10", 12" or 16" long to accommodate small corbels or large columns. The horizontal extensions can either be coped (see page 23), mitered (see page 23), or with extended capitals (drawing on page 4) to achieve the desired design.
- Units to accommodate columns are available in Elliptical and Eyebrow.
- Extended Capitals are typically used with an arcade of arches.
- Columns are not included.

	Coped Horizontal Extensions	Mitered Horizontal Extensions	Extended Capitals
Profile Availability	All Profiles except #430 or #510	All Profiles	All Profiles
Keystone	Yes	Yes	Yes
Recessed Panels	Yes- Panels will not be on Horizontal Extension to allow for column/corbel placement	Yes- Panels will not be on Horizontal Extension to allow for column/corbel placement	Yes- Panels will not be on Horizontal Extension to allow for column/corbel placement
Backband #175	#500, #510, #520, #560, #460, #420, #430- Backband will only be on curved header.	#500, #510, #520, #560, #460, #420, #430 - Backband will be on curved header and straights	#500, #510, #520, #560, #460, #420, #430 - Backband will only be on curved header .
Backband #106	#500, #510, #520, #560, #460, #420, #430- Backband will only be on curved header.	#500, #510, #520, #560, #460, #420, #430 - Backband will be on curved header and straights.	#500, #510, #520, #560, #460, #420, #430 - Backband will only be on curved header .
#625 Fluted Pilaster	Not Available	Not Available	Not Available

Elliptical Horizontal Extensions Framing Specs - 12" Rise

Opening Model #	Rough Opening Width	Finished Opening Width	"A"	"B"	"C"	"D"	"E"	"F"
62-2",12"rise	62min - 65"max	59	22	10	10	6	2	13 3/8
62-8",12"rise		"	16	9 1/2	9 1/2	6	8	13 3/8
62-10",12"rise		"	15	9	9 1/2	6	10	13 3/8
62-12",12"rise		"	14	8 1/2	8 1/2	5 1/2	12	13 3/8
62-16",12"rise		"	12	8 1/2	8 1/2	5 1/2	16	13 3/8
66-2",12"rise	66min - 69"max	63	22	10	10	6	2	13 3/8
66-8",12"rise		"	17	9 1/2	9 1/2	6	8	13 3/8
66-10",12"rise		"	16	9 1/2	9 1/2	6	10	13 3/8
66-12",12"rise		"	15	9	9 1/2	6	12	13 3/8
66-16",12"rise		"	12	8 1/2	8 1/2	5 1/2	16	13 3/8
70-2",12"rise	70min - 73"max	67	24	10	10	5 1/2	2	13 3/8
70-8",12"rise		"	19	9 1/2	9 1/2	6	8	13 3/8
70-10",12"rise		"	17	9 1/2	9 1/2	6	10	13 3/8
70-12",12"rise		"	16	9 1/2	9 1/2	6	12	13 3/8
70-16",12"rise		"	14	8 1/2	8 1/2	5 1/2	16	13 3/8
74-2",12"rise	74min - 77"max	71	24	10	10	5 1/2	2	13 3/8
74-8",12"rise		"	22	10	10	6	8	13 3/8
74-10",12"rise		"	19	9 1/2	9 1/2	6	10	13 3/8
74-12",12"rise		"	17	9 1/2	9 1/2	6	12	13 3/8
74-16",12"rise		"	15	9	9 1/2	6	16	13 3/8
78-2",12"rise	78min - 81"max	75	27	10 1/2	10 1/2	5 1/2	2	13 3/8
78-8",12"rise		"	22	10	10	6	8	13 3/8
78-10",12"rise		"	22	10	10	6	10	13 3/8
78-12",12"rise		"	19	9 1/2	9 1/2	6	12	13 3/8
78-16",12"rise		"	16	9 1/2	9 1/2	6	16	13 3/8
82-2",12"rise	82min - 85"max	79	27	10 1/2	10 1/2	5 1/2	2	13 3/8
82-8",12"rise		"	24	10	10	5 1/2	8	13 3/8
82-10",12"rise		"	22	10	10	6	10	13 3/8
82-12",12"rise		"	22	10	10	6	12	13 3/8
82-16",12"rise		"	17	9 1/2	9 1/2	6	16	13 3/8
86-2",12"rise	86min - 89"max	83	30	10 1/2	10 1/2	5 1/2	2	13 3/8
86-8",12"rise		"	24	10	10	5 1/2	8	13 3/8
86-10",12"rise		"	24	10	10	5 1/2	10	13 3/8
86-12",12"rise		"	22	10	10	6	12	13 3/8
86-16",12"rise		"	19	9 1/2	9 1/2	6	16	13 3/8
90-2",12"rise	90min - 93"max	87	30	10 1/2	10 1/2	5 1/2	2	13 3/8
90-8",12"rise		"	27	10 1/2	10 1/2	5 1/2	8	13 3/8
90-10",12"rise		"	24	10	10	5 1/2	10	13 3/8
90-12",12"rise		"	24	10	10	5 1/2	12	13 3/8
90-16",12"rise		"	22	10	10	6	16	13 3/8
94-2",12"rise	94min - 97"max	91	33	10 1/2	10 1/2	5 1/2	2	13 3/8
94-8",12"rise		"	27	10 1/2	10 1/2	5 1/2	8	13 3/8
94-10",12"rise		"	27	10 1/2	10 1/2	5 1/2	10	13 3/8
94-12",12"rise		"	24	10	10	5 1/2	12	13 3/8
94-16",12"rise		"	22	10	10	6	16	13 3/8

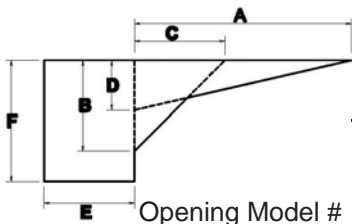

Elliptical Horizontal Extensions Framing Specs - 12" Rise

Opening Model #	Rough Opening Width	Finished Opening Width	"A"	"B"	"C"	"D"	"E"	"F"
98-2", 12"rise	98min - 101"max	95	33	10 1/2	10 1/2	5 1/2	2	13 3/8
98-8", 12"rise		"	30	10 1/2	10 1/2	5 1/2	8	13 3/8
98-10", 12"rise		"	27	10 1/2	10 1/2	5 1/2	10	13 3/8
98-12", 12"rise		"	27	10 1/2	10 1/2	5 1/2	12	13 3/8
98-16", 12"rise		"	24	10	10	5 1/2	16	13 3/8
102-2", 12"rise	102"min - 105"max	99	35	10 1/2	10 1/2	5 1/2	2	13 3/8
102-8", 12"rise		"	30	10 1/2	10 1/2	5 1/2	8	13 3/8
102-10", 12"rise		"	30	10 1/2	10 1/2	5 1/2	10	13 3/8
102-12", 12"rise		"	27	10 1/2	10 1/2	5 1/2	12	13 3/8
102-16", 12"rise		"	24	10	10	5 1/2	16	13 3/8
106-2", 12"rise	106"min - 109"max	103	35	10 1/2	10 1/2	5 1/2	2	13 3/8
106-8", 12"rise		"	33	10 1/2	10 1/2	5 1/2	8	13 3/8
106-10", 12"rise		"	30	10 1/2	10 1/2	5 1/2	10	13 3/8
106-12", 12"rise		"	30	10 1/2	10 1/2	5 1/2	12	13 3/8
106-16", 12"rise		"	27	10 1/2	10 1/2	5 1/2	16	13 3/8
110-2", 12"rise	110" min - 113"max	107	35	10 1/2	10 1/2	5 1/2	2	13 3/8
110-8", 12"rise		"	33	10 1/2	10 1/2	5 1/2	8	13 3/8
110-10", 12"rise		"	33	10 1/2	10 1/2	5 1/2	10	13 3/8
110-12", 12"rise		"	30	10 1/2	10 1/2	5 1/2	12	13 3/8
110-16", 12"rise		"	27	10 1/2	10 1/2	5 1/2	16	13 3/8
114-2", 12"rise	114" min - 117"max	111	35	10 1/2	10 1/2	5 1/2	2	13 3/8
114-8", 12"rise		"	35	10 1/2	10 1/2	5 1/2	8	13 3/8
114-10", 12"rise		"	33	10 1/2	10 1/2	5 1/2	10	13 3/8
114-12", 12"rise		"	33	10 1/2	10 1/2	5 1/2	12	13 3/8
114-16", 12"rise		"	30	10 1/2	10 1/2	5 1/2	16	13 3/8
118-2", 12"rise	118"min - 121"max	115	36	10 1/2	10 1/2	5 1/2	2	13 3/8
118-8", 12"rise		"	35	10 1/2	10 1/2	5 1/2	8	13 3/8
118-10", 12"rise		"	35	10 1/2	10 1/2	5 1/2	10	13 3/8
118-12", 12"rise		"	33	10 1/2	10 1/2	5 1/2	12	13 3/8
118-16", 12"rise		"	30	10 1/2	10 1/2	5 1/2	16	13 3/8
122-2", 12"rise	122"min - 125"max	119	36	10 1/2	10 1/2	6	2	13 3/8
122-8", 12"rise		"	35	10 1/2	10 1/2	5 1/2	8	13 3/8
122-10", 12"rise		"	35	10 1/2	10 1/2	5 1/2	10	13 3/8
122-12", 12"rise		"	35	10 1/2	10 1/2	5 1/2	12	13 3/8
122-16", 12"rise		"	33	10 1/2	10 1/2	5 1/2	16	13 3/8
126-2", 12"rise	126" min- 129"max	123	41	10 1/2	10 1/2	6	2	13 3/8
126-8", 12"rise		"	35	10 1/2	10 1/2	5 1/2	8	13 3/8
126-10", 12"rise		"	35	10 1/2	10 1/2	5 1/2	10	13 3/8
126-12", 12"rise		"	35	10 1/2	10 1/2	5 1/2	12	13 3/8
126-16", 12"rise		"	33	10 1/2	10 1/2	5 1/2	16	13 3/8
130-2", 12"rise	130" min - 133"max	127	41	10 1/4	10 1/4	6	2	13 3/8
130-8", 12"rise		"	36	10 1/2	10 1/2	5 1/2	8	13 3/8
130-10", 12"rise		"	35	10 1/2	10 1/2	5 1/2	10	13 3/8
130-12", 12"rise		"	35	10 1/2	10 1/2	5 1/2	12	13 3/8
130-16", 12"rise		"	35	10 1/2	10 1/2	5 1/2	16	13 3/8

** Outside Finished Width on Units with Horizontal Extensions differ from units without Horizontal Extensions.

Call for specific dimensions **

Elliptical Horizontal Extensions Framing Specs - 12" Rise

Opening Model #	Rough Opening Width	Finished Opening Width	"A"	"B"	"C"	"D"	"E"	"F"
134-2",12"rise	134" min-137" max	131	43	10 1/4	10 1/4	6	2	13 3/8
134-8",12"rise		"	36	10 1/2	10 1/2	5 1/2	8	13 3/8
134-10",12"rise		"	36	10 1/2	10 1/2	5 1/2	10	13 3/8
134-12",12"rise		"	35	10 1/2	10 1/2	5 1/2	12	13 3/8
134-16",12"rise		"	35	10 1/2	10 1/2	5 1/2	16	13 3/8
138-2",12"rise	138" min-141" max	135	43	10 1/4	10 1/4	6	2	13 3/8
138-8",12"rise		"	41	10 1/4	10 1/4	6	8	13 3/8
138-10",12"rise		"	36	10 1/2	10 1/2	5 1/2	10	13 3/8
138-12",12"rise		"	36	10 1/2	10 1/2	5 1/2	12	13 3/8
138-16",12"rise		"	35	10 1/2	10 1/2	5 1/2	16	13 3/8
142-2",12"rise	142" min - 145" max	139	46	10 1/4	10 1/4	6	2	13 3/8
142-8",12"rise		"	41	10 1/4	10 1/4	6	8	13 3/8
142-10",12"rise		"	41	10 1/4	10 1/4	6	10	13 3/8
142-12",12"rise		"	36	10 1/2	10 1/2	5 1/2	12	13 3/8
142-16",12"rise		"	35	10 1/2	10 1/2	5 1/2	16	13 3/8
146-2",12"rise	146" min - 149" max	143	46	10 1/4	10 1/4	6	2	13 3/8
146-8",12"rise		"	43	10 1/4	10 1/4	6	8	13 3/8
146-10",12"rise		"	41	10 1/4	10 1/4	6	10	13 3/8
146-12",12"rise		"	41	10 1/4	10 1/4	6	12	13 3/8
146-16",12"rise		"	36	10 1/2	10 1/2	5 1/2	16	13 3/8
150-2",12"rise	150" min - 153" max	147	49	10 1/4	10 1/4	6	2	13 3/8
150-8",12"rise		"	43	10 1/4	10 1/4	6	8	13 3/8
150-10",12"rise		"	43	10 1/4	10 1/4	6	10	13 3/8
150-12",12"rise		"	41	10 1/4	10 1/4	6	12	13 3/8
150-16",12"rise		"	36	10 1/2	10 1/2	5 1/2	16	13 3/8
154-2",12"rise	154" min - 157"max	151	49	10 1/4	10 1/4	5 3/4	2	13 3/8
154-8",12"rise		"	46	10 1/4	10 1/4	6	8	13 3/8
154-10",12"rise		"	43	10 1/4	10 1/4	6	10	13 3/8
154-12",12"rise		"	43	10 1/4	10 1/4	6	12	13 3/8
154-16",12"rise		"	41	10 1/4	10 1/4	6	16	13 3/8
158-2",12"rise	158" min - 161" max	155	51	10 1/4	10 1/4	5 3/4	2	13 3/8
158-8",12"rise		"	46	10 1/4	10 1/4	6	8	13 3/8
158-10",12"rise		"	46	10 1/4	10 1/4	6	10	13 3/8
158-12",12"rise		"	43	10 1/4	10 1/4	6	12	13 3/8
158-16",12"rise		"	41	10 1/4	10 1/4	6	16	13 3/8
162-2",12"rise	162" min - 165" max	159	51	10 1/4	10 1/4	5 3/4	2	13 3/8
162-8",12"rise		"	49	10 1/4	10 1/4	5 3/4	8	13 3/8
162-10",12"rise		"	46	10 1/4	10 1/4	6	10	13 3/8
162-12",12"rise		"	46	10 1/4	10 1/4	6	12	13 3/8
162-16",12"rise		"	43	10 1/4	10 1/4	6	16	13 3/8
166-2",12"rise	166" min - 169" max	163	53	10 1/4	10 1/4	5 3/4	2	13 3/8
166-8",12"rise		"	49	10 1/4	10 1/4	5 3/4	8	13 3/8
166-10",12"rise		"	49	10 1/4	10 1/4	5 3/4	10	13 3/8
166-12",12"rise		"	46	10 1/4	10 1/4	6	12	13 3/8
166-16",12"rise		"	43	10 1/4	10 1/4	6	16	13 3/8
170-2",12"rise	170" min - 173" max	167	53	10 1/4	10 1/4	5 3/4	2	13 3/8
170-8",12"rise		"	51	10 1/4	10 1/4	5 3/4	8	13 3/8
170-10",12"rise		"	49	10 1/4	10 1/4	5 3/4	10	13 3/8
170-12",12"rise		"	49	10 1/4	10 1/4	5 3/4	12	13 3/8
170-16",12"rise		"	46	10 1/4	10 1/4	6	16	13 3/8

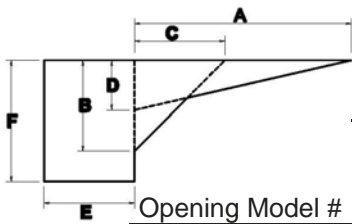

Elliptical Horizontal Extensions Framing Specs - 20" Rise

Opening Model #	Rough Opening Width	Finished Opening Width	"A"	"B"	"C"	"D"	"E"	"F"
62-2",20"rise	62min - 65"max	59	17	17 1/2	8	12 1/2	2	21 3/8
62-8",20"rise		"	14	17	7 1/2	11	8	21 3/8
62-10",20"rise		"	16	16	8	8	10	21 3/8
62-12",20"rise		"	15	15	7	7	12	21 3/8
62-16",20"rise		"	11	11	6	6	16	21 3/8
66-2",20"rise	66min - 69"max	63	18	17 1/2	8	12 1/2	2	21 3/8
66-8",20"rise		"	15	17 1/2	7 1/2	12 1/2	8	21 3/8
66-10",20"rise		"	14	17	7 1/2	11	10	21 3/8
66-12",20"rise		"	16	16	8	8	12	21 3/8
66-16",20"rise		"	13	13	7	7	16	21 3/8
70-2",20"rise	70min - 73"max	67	19	17 1/2	9	12 1/2	2	21 3/8
70-8",20"rise		"	16	17 1/2	8	12 1/2	8	21 3/8
70-10",20"rise		"	15	17 1/2	7 1/2	12 1/2	10	21 3/8
70-12",20"rise		"	14	17	7 1/2	11	12	21 3/8
70-16",20"rise		"	15	15	7	7	16	21 3/8
74-2",20"rise	74min - 77"max	71	20	17 1/2	10	12 1/2	2	21 3/8
74-8",20"rise		"	17	17 1/2	8	12 1/2	8	21 3/8
74-10",20"rise		"	16	17 1/2	8	12 1/2	10	21 3/8
74-12",20"rise		"	15	17 1/2	7 1/2	12 1/2	12	21 3/8
74-16",20"rise		"	16	16	8	8	16	21 3/8
78-2",20"rise	78min - 81"max	75	21	17 1/2	10	12 1/2	2	21 3/8
78-8",20"rise		"	18	17 1/2	8	12 1/2	8	21 3/8
78-10",20"rise		"	17	17 1/2	8	12 1/2	10	21 3/8
78-12",20"rise		"	16	17 1/2	8	12 1/2	12	21 3/8
78-16",20"rise		"	14	17	7 1/2	11	16	21 3/8
82-2",20"rise	82min - 85"max	79	22	17 1/2	11	12 1/2	2	21 3/8
82-8",20"rise		"	19	17 1/2	9	12 1/2	8	21 3/8
82-10",20"rise		"	18	17 1/2	8	12 1/2	10	21 3/8
82-12",20"rise		"	17	17 1/2	8	12 1/2	12	21 3/8
82-16",20"rise		"	15	17 1/2	7 1/2	12 1/2	16	21 3/8
86-2",20"rise	86min - 89"max	83	23	17 1/2	12	12 1/2	2	21 3/8
86-8",20"rise		"	20	17 1/2	10	12 1/2	8	21 3/8
86-10",20"rise		"	19	17 1/2	9	12 1/2	10	21 3/8
86-12",20"rise		"	18	17 1/2	8	12 1/2	12	21 3/8
86-16",20"rise		"	16	17 1/2	8	12 1/2	16	21 3/8
90-2",20"rise	90min - 93"max	87	25	18	12	12 1/2	2	21 3/8
90-8",20"rise		"	21	17 1/2	10	12 1/2	8	21 3/8
90-10",20"rise		"	20	17 1/2	10	12 1/2	10	21 3/8
90-12",20"rise		"	19	17 1/2	9	12 1/2	12	21 3/8
90-16",20"rise		"	17	17 1/2	8	12 1/2	16	21 3/8
94-2",20"rise	94min - 97"max	91	26	18	12	12 1/2	2	21 3/8
94-8",20"rise		"	22	17 1/2	11	12 1/2	8	21 3/8
94-10",20"rise		"	21	17 1/2	10	12 1/2	10	21 3/8
94-12",20"rise		"	20	17 1/2	10	12 1/2	12	21 3/8
94-16",20"rise		"	18	17 1/2	8	12 1/2	16	21 3/8

** Outside Finished Width on Units with Horizontal Extensions differ from units without Horizontal Extensions.

Call for specific dimensions **

Elliptical Horizontal Extensions Framing Specs - 20" Rise

Opening Model #	Rough Opening Width	Finished Opening Width	"A"	"B"	"C"	"D"	"E"	"F"
98-2",20"rise	98min - 101"max	95	27	18	13	12 1/2	2	21 3/8
98-8",20"rise		"	23	17 1/2	12	12 1/2	8	21 3/8
98-10",20"rise		"	22	17 1/2	11	12 1/2	10	21 3/8
98-12",20"rise		"	21	17 1/2	10	12 1/2	12	21 3/8
98-16",20"rise		"	19	17 1/2	9	12 1/2	16	21 3/8
102-2",20"rise	102"min - 105"max	99	28	18	13	12 1/2	2	21 3/8
102-8",20"rise		"	25	18	12	12 1/2	8	21 3/8
102-10",20"rise		"	23	17 1/2	12	12 1/2	10	21 3/8
102-12",20"rise		"	22	17 1/2	11	12 1/2	12	21 3/8
102-16",20"rise		"	20	17 1/2	10	12 1/2	16	21 3/8
106-2",20"rise	106"min - 109"max	103	29	18	13	12 1/2	2	21 3/8
106-8",20"rise		"	26	18	12	12 1/2	8	21 3/8
106-10",20"rise		"	25	18	12	12 1/2	10	21 3/8
106-12",20"rise		"	23	17 1/2	12	12 1/2	12	21 3/8
106-16",20"rise		"	21	17 1/2	10	12 1/2	16	21 3/8
110-2",20"rise	110" min - 113"max	107	30	18	13	12 1/2	2	21 3/8
110-8",20"rise		"	27	18	13	12 1/2	8	21 3/8
110-10",20"rise		"	26	18	12	12 1/2	10	21 3/8
110-12",20"rise		"	25	18	12	12 1/2	12	21 3/8
110-16",20"rise		"	22	17 1/2	11	12 1/2	16	21 3/8
114-2",20"rise	114" min - 117"max	111	31	18	13	12 1/2	2	21 3/8
114-8",20"rise		"	28	18	13	12 1/2	8	21 3/8
114-10",20"rise		"	27	18	13	12 1/2	10	21 3/8
114-12",20"rise		"	26	18	12	12 1/2	12	21 3/8
114-16",20"rise		"	23	17 1/2	12	12 1/2	16	21 3/8
118-2",20"rise	118"min - 121"max	115	33	18 1/2	13 1/2	12 1/2	2	21 3/8
118-8",20"rise		"	29	18	13	12 1/2	8	21 3/8
118-10",20"rise		"	28	18	13	12 1/2	10	21 3/8
118-12",20"rise		"	27	18	13	12 1/2	12	21 3/8
118-16",20"rise		"	25	18	12	12 1/2	16	21 3/8
122-2",20"rise	122"min - 125"max	119	33	18 1/2	13 1/2	12 1/2	2	21 3/8
122-8",20"rise		"	30	18	13	12 1/2	8	21 3/8
122-10",20"rise		"	29	18	13	12 1/2	10	21 3/8
122-12",20"rise		"	28	18	13	12 1/2	12	21 3/8
122-16",20"rise		"	26	18	12	12 1/2	16	21 3/8
126-2",20"rise	126" min- 129"max	123	35	18 1/2	14 1/2	12 1/2	2	21 3/8
126-8",20"rise		"	31	18	13	12 1/2	8	21 3/8
126-10",20"rise		"	30	18	13	12 1/2	10	21 3/8
126-12",20"rise		"	29	18	13	12 1/2	12	21 3/8
126-16",20"rise		"	27	18	13	12 1/2	16	21 3/8
130-2",20"rise	130" min - 133"max	127	35	18 1/2	14 1/2	12 1/2	2	21 3/8
130-8",20"rise		"	33	18 1/2	13 1/2	12 1/2	8	21 3/8
130-10",20"rise		"	31	18	13	12 1/2	10	21 3/8
130-12",20"rise		"	30	18	13	12 1/2	12	21 3/8
130-16",20"rise		"	28	18	13	12 1/2	16	21 3/8
134-2",20"rise	134" min- 137" max	131	37	18 1/2	15	12 1/2	2	21 3/8
134-8",20"rise		"	33	18 1/2	13 1/2	12 1/2	8	21 3/8
134-10",20"rise		"	33	18 1/2	13 1/2	12 1/2	10	21 3/8
134-12",20"rise		"	31	18	13	12 1/2	12	21 3/8
134-16",20"rise		"	29	18	13	12 1/2	16	21 3/8

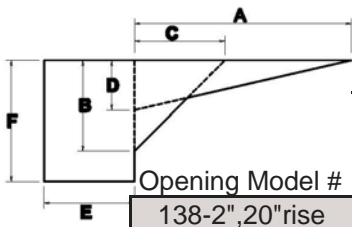

Elliptical Horizontal Extensions Framing Specs - 20" Rise

Opening Model #	Rough Opening Width	Finished Opening Width	"A"	"B"	"C"	"D"	"E"	"F"
138-2",20"rise	138" min-141" max	135	37	18 1/2	15	12 1/2	2	21 3/8
138-8",20"rise		"	35	18 1/2	14 1/2	12 1/2	8	21 3/8
138-10",20"rise		"	33	18 1/2	13 1/2	12 1/2	10	21 3/8
138-12",20"rise		"	33	18 1/2	13 1/2	12 1/2	12	21 3/8
138-16",20"rise		"	30	18	13	12 1/2	16	21 3/8
142-2",20"rise	142" min - 145" max	139	39	18 1/2	15	12 1/2	2	21 3/8
142-8",20"rise		"	35	18 1/2	14 1/2	12 1/2	8	21 3/8
142-10",20"rise		"	35	18 1/2	14 1/2	12 1/2	10	21 3/8
142-12",20"rise		"	33	18 1/2	13 1/2	12 1/2	12	21 3/8
142-16",20"rise		"	31	18	13	12 1/2	16	21 3/8
146-2",20"rise	146" min - 149" max	143	39	18 1/2	15	12 1/2	2	21 3/8
146-8",20"rise		"	37	18 1/2	15	12 1/2	8	21 3/8
146-10",20"rise		"	35	18 1/2	14 1/2	12 1/2	10	21 3/8
146-12",20"rise		"	35	18 1/2	14 1/2	12 1/2	12	21 3/8
146-16",20"rise		"	33	18 1/2	13 1/2	12 1/2	16	21 3/8
150-2",20"rise	150" min - 153" max	147	41	18 1/2	16	12 1/2	2	21 3/8
150-8",20"rise		"	37	18 1/2	15	12 1/2	8	21 3/8
150-10",20"rise		"	37	18 1/2	15	12 1/2	10	21 3/8
150-12",20"rise		"	35	18 1/2	14 1/2	12 1/2	12	21 3/8
150-16",20"rise		"	33	18 1/2	13 1/2	12 1/2	16	21 3/8
154-2",20"rise	154" min - 157"max	151	41	18 1/2	16	12 1/2	2	21 3/8
154-8",20"rise		"	39	18 1/2	15	12 1/2	8	21 3/8
154-10",20"rise		"	37	18 1/2	15	12 1/2	10	21 3/8
154-12",20"rise		"	37	18 1/2	15	12 1/2	12	21 3/8
154-16",20"rise		"	35	18 1/2	14 1/2	12 1/2	16	21 3/8
158-2",20"rise	158" min - 161" max	155	43	18 1/2	17	12 1/2	2	21 3/8
158-8",20"rise		"	39	18 1/2	15	12 1/2	8	21 3/8
158-10",20"rise		"	39	18 1/2	15	12 1/2	10	21 3/8
158-12",20"rise		"	37	18 1/2	15	12 1/2	12	21 3/8
158-16",20"rise		"	35	18 1/2	14 1/2	12 1/2	16	21 3/8
162-2",20"rise	162" min - 165" max	159	43	18 1/2	17	12 1/2	2	21 3/8
162-8",20"rise		"	41	18 1/2	16	12 1/2	8	21 3/8
162-10",20"rise		"	39	18 1/2	15	12 1/2	10	21 3/8
162-12",20"rise		"	39	18 1/2	15	12 1/2	12	21 3/8
162-16",20"rise		"	37	18 1/2	15	12 1/2	16	21 3/8
166-2",20"rise	166" min - 169" max	163	46	18 1/2	18	12 1/2	2	21 3/8
166-8",20"rise		"	41	18 1/2	16	12 1/2	8	21 3/8
166-10",20"rise		"	41	18 1/2	16	12 1/2	10	21 3/8
166-12",20"rise		"	39	18 1/2	15	12 1/2	12	21 3/8
166-16",20"rise		"	37	18 1/2	15	12 1/2	16	21 3/8
170-2",20"rise	170" min - 173" max	167	46	18 1/2	18	12 1/2	2	21 3/8
170-8",20"rise		"	43	18 1/2	17	12 1/2	8	21 3/8
170-10",20"rise		"	41	18 1/2	16	12 1/2	10	21 3/8
170-12",20"rise		"	41	18 1/2	16	12 1/2	12	21 3/8
170-16",20"rise		"	39	18 1/2	15	12 1/2	16	21 3/8

** Outside Finished Width on Units with Horizontal Extensions differ from units without Horizontal Extensions.
Call for specific dimensions **

Eyebrow Horizontal Extensions Framing Specs - 12" Rise

Opening Model #	Rough Opening Width	Finished Opening Width	"A"	"B"	"C"	"D"	"E"	"F"
62-2", 12"rise	62min - 65"max	59	20	12	12	9	2	13 3/8
62-8", 12"rise		"	16	11	11	7	8	13 3/8
62-10", 12"rise		"	15	10 1/2	10 1/2	7	10	13 3/8
62-12", 12"rise		"	14	10	10	5 1/2	12	13 3/8
62-16", 12"rise		"	12	8 1/2	8 1/2	5 1/2	16	13 3/8
66-2", 12"rise	66min - 69"max	63	20	12	12	9	2	13 3/8
66-8", 12"rise		"	17	11 1/2	11 1/2	8	8	13 3/8
66-10", 12"rise		"	16	11	11	7	10	13 3/8
66-12", 12"rise		"	15	10 1/2	10 1/2	7	12	13 3/8
66-16", 12"rise		"	12	9	9	5 1/2	16	13 3/8
70-2", 12"rise	70min - 73"max	67	20	11 1/2			2	13 3/8
70-8", 12"rise		"	20	12	12	8	8	13 3/8
70-10", 12"rise		"	17	11 1/2	11 1/2	8	10	13 3/8
70-12", 12"rise		"	16	11	11	7	12	13 3/8
70-16", 12"rise		"	14	10	10	5 1/2	16	13 3/8
74-2", 12"rise	74min - 77"max	71	21	11 1/2			2	13 3/8
74-8", 12"rise		"	20	12	12	9	8	13 3/8
74-10", 12"rise		"	20	12	12	8	10	13 3/8
74-12", 12"rise		"	20	11 1/2	11 1/2	8	12	13 3/8
74-16", 12"rise		"	15	10 1/2	10 1/2	7	16	13 3/8
78-2", 12"rise	78min - 81"max	75	23	11 1/2			2	13 3/8
78-8", 12"rise		"	20	12	12	9	8	13 3/8
78-10", 12"rise		"	20	12	12	9	10	13 3/8
78-12", 12"rise		"	20	12	12	8	12	13 3/8
78-16", 12"rise		"	16	11	11	7	16	13 3/8
82-2", 12"rise	82min - 85"max	79	24	11 1/2			2	13 3/8
82-8", 12"rise		"	20	11 1/2			8	13 3/8
82-10", 12"rise		"	20	12	12	9	10	13 3/8
82-12", 12"rise		"	20	12	12	9	12	13 3/8
82-16", 12"rise		"	17	11 1/2	11 1/2	8	16	13 3/8
86-2", 12"rise	86min - 89"max	83	25	11 1/2			2	13 3/8
86-8", 12"rise		"	21	11 1/2			8	13 3/8
86-10", 12"rise		"	20	11 1/2			10	13 3/8
86-12", 12"rise		"	20	12	12	9	12	13 3/8
86-16", 12"rise		"	20	12	12	8	16	13 3/8
90-2", 12"rise	90min - 93"max	87	26	11 1/2			2	13 3/8
90-8", 12"rise		"	23	11 1/2			8	13 3/8
90-10", 12"rise		"	21	11 1/2			10	13 3/8
90-12", 12"rise		"	20	11 1/2			12	13 3/8
90-16", 12"rise		"	20	12	12	9	16	13 3/8
94-2", 12"rise	94min - 97"max	91	29	11			2	13 3/8
94-8", 12"rise		"	24	11 1/2			8	13 3/8
94-10", 12"rise		"	23	11 1/2			10	13 3/8
94-12", 12"rise		"	21	11 1/2			12	13 3/8
94-16", 12"rise		"	20	12	12	9	16	13 3/8

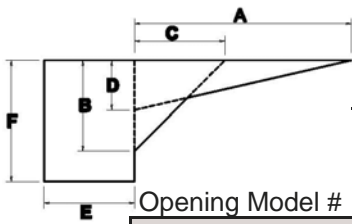

Eyebrow Horizontal Extensions Framing Specs - 12" Rise

Opening Model #	Rough Opening Width	Finished Opening Width	"A"	"B"	"C"	"D"	"E"	"F"
98-2", 12"rise	98min - 101"max	95	30	11	Only Requires "A" and "B" Framing Dimensions	Dimensions	2	13 3/8
98-8", 12"rise		"	25	11 1/2			8	13 3/8
98-10", 12"rise		"	24	11 1/2			10	13 3/8
98-12", 12"rise		"	23	11 1/2			12	13 3/8
98-16", 12"rise		"	20	11 1/2			16	13 3/8
102-2", 12"rise	102"min - 105"max	99	31	11			2	13 3/8
102-8", 12"rise		"	26	11 1/2			8	13 3/8
102-10", 12"rise		"	25	11 1/2			10	13 3/8
102-12", 12"rise		"	24	11 1/2			12	13 3/8
102-16", 12"rise		"	21	11 1/2			16	13 3/8
106-2", 12"rise	106"min - 109"max	103	32	11			2	13 3/8
106-8", 12"rise		"	29	11			8	13 3/8
106-10", 12"rise		"	26	11 1/2			10	13 3/8
106-12", 12"rise		"	25	11 1/2			12	13 3/8
106-16", 12"rise		"	23	11 1/2			16	13 3/8
110-2", 12"rise	110" min - 113"max	107	34	11			2	13 3/8
110-8", 12"rise		"	30	11			8	13 3/8
110-10", 12"rise		"	29	11			10	13 3/8
110-12", 12"rise		"	26	11 1/2			12	13 3/8
110-16", 12"rise		"	24	11 1/2			16	13 3/8
114-2", 12"rise	114" min - 117"max	111	35	11			2	13 3/8
114-8", 12"rise		"	31	11			8	13 3/8
114-10", 12"rise		"	30	11			10	13 3/8
114-12", 12"rise		"	29	11			12	13 3/8
114-16", 12"rise		"	25	11 1/2			16	13 3/8
118-2", 12"rise	118"min - 121"max	115	36	11			2	13 3/8
118-8", 12"rise		"	32	11			8	13 3/8
118-10", 12"rise		"	31	11			10	13 3/8
118-12", 12"rise		"	30	11	12	13 3/8		
118-16", 12"rise		"	26	11 1/2	16	13 3/8		
122-2", 12"rise	122"min - 125"max	119	37	11	2	13 3/8		
122-8", 12"rise		"	34	11	8	13 3/8		
122-10", 12"rise		"	32	11	10	13 3/8		
122-12", 12"rise		"	31	11	12	13 3/8		
122-16", 12"rise		"	29	11	16	13 3/8		
126-2", 12"rise	126" min- 129"max	123	38	11	2	13 3/8		
126-8", 12"rise		"	35	11	8	13 3/8		
126-10", 12"rise		"	34	11	10	13 3/8		
126-12", 12"rise		"	32	11	12	13 3/8		
126-16", 12"rise		"	30	11	16	13 3/8		
130-2", 12"rise	130" min - 133"max	127	40	11	2	13 3/8		
130-8", 12"rise		"	36	11	8	13 3/8		
130-10", 12"rise		"	35	11	10	13 3/8		
130-12", 12"rise		"	34	11	12	13 3/8		
130-16", 12"rise		"	31	11	16	13 3/8		

Eyebrow Horizontal Extensions Framing Specs - 12" Rise

Opening Model #	Rough Opening Width	Finished Opening Width	"A"	"B"	"C"	"D"	"E"	"F"
134-2", 12"rise	134" min-137" max	131	41	11	Only Requires "A" and "B" Framing Dimensions	Only Requires "A" and "B" Framing Dimensions	2	13 3/8
134-8", 12"rise		"	37	11			8	13 3/8
134-10", 12"rise		"	36	11			10	13 3/8
134-12", 12"rise		"	35	11			12	13 3/8
134-16", 12"rise		"	32	11			16	13 3/8
138-2", 12"rise	138" min-141" max	135	43	11			2	13 3/8
138-8", 12"rise		"	38	11			8	13 3/8
138-10", 12"rise		"	37	11			10	13 3/8
138-12", 12"rise		"	36	11			12	13 3/8
138-16", 12"rise		"	34	11			16	13 3/8
142-2", 12"rise	142" min - 145" max	139	44	11			2	13 3/8
142-8", 12"rise		"	40	11			8	13 3/8
142-10", 12"rise		"	38	11			10	13 3/8
142-12", 12"rise		"	37	11			12	13 3/8
142-16", 12"rise		"	35	11			16	13 3/8
146-2", 12"rise	146" min - 149" max	143	45	11			2	13 3/8
146-8", 12"rise		"	41	11			8	13 3/8
146-10", 12"rise		"	40	11			10	13 3/8
146-12", 12"rise		"	38	11			12	13 3/8
146-16", 12"rise		"	36	11			16	13 3/8
150-2", 12"rise	150" min - 153" max	147	46	11			2	13 3/8
150-8", 12"rise		"	43	11			8	13 3/8
150-10", 12"rise		"	41	11			10	13 3/8
150-12", 12"rise		"	40	11			12	13 3/8
150-16", 12"rise		"	37	11			16	13 3/8
154-2", 12"rise	154" min - 157" max	151	48	11			2	13 3/8
154-8", 12"rise		"	44	11			8	13 3/8
154-10", 12"rise		"	43	11			10	13 3/8
154-12", 12"rise		"	41	11	12	13 3/8		
154-16", 12"rise		"	38	11	16	13 3/8		
158-2", 12"rise	158" min - 161" max	155	49	11	2	13 3/8		
158-8", 12"rise		"	45	11	8	13 3/8		
158-10", 12"rise		"	44	11	10	13 3/8		
158-12", 12"rise		"	43	11	12	13 3/8		
158-16", 12"rise		"	40	11	16	13 3/8		
162-2", 12"rise	162" min - 165" max	159	50	11	2	13 3/8		
162-8", 12"rise		"	46	11	8	13 3/8		
162-10", 12"rise		"	45	11	10	13 3/8		
162-12", 12"rise		"	44	11	12	13 3/8		
162-16", 12"rise		"	41	11	16	13 3/8		
166-2", 12"rise	166" min - 169" max	163	51	11	2	13 3/8		
166-8", 12"rise		"	48	11	8	13 3/8		
166-10", 12"rise		"	46	11	10	13 3/8		
166-12", 12"rise		"	45	11	12	13 3/8		
166-16", 12"rise		"	43	11	16	13 3/8		
170-2", 12"rise	170" min - 173" max	167	52	11	2	13 3/8		
170-8", 12"rise		"	49	11	8	13 3/8		
170-10", 12"rise		"	48	11	10	13 3/8		
170-12", 12"rise		"	46	11	12	13 3/8		
170-16", 12"rise		"	44	11	16	13 3/8		

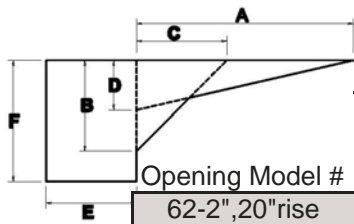

Eyebrow Horizontal Extensions Framing Specs - 20" Rise

Opening Model #	Rough Opening Width	Finished Opening Width	"A"	"B"	"C"	"D"	"E"	"F"
62-2",20"rise	62min - 65"max	59	21	19	12	12	2	21 3/8
62-8",20"rise		"	15	17	8	11	8	21 3/8
62-10",20"rise		"	16	16	8	8	10	21 3/8
62-12",20"rise		"	15	15	7	7	12	21 3/8
62-16",20"rise		"	11	11	6	6	16	21 3/8
66-2",20"rise	66min - 69"max	63	22	19	14	12	2	21 3/8
66-8",20"rise		"	17	18	9	11	8	21 3/8
66-10",20"rise		"	15	17	8	11	10	21 3/8
66-12",20"rise		"	16	16	8	8	12	21 3/8
66-16",20"rise		"	13	13	7	7	16	21 3/8
70-2",20"rise	70min - 73"max	67	24	19	16	12	2	21 3/8
70-8",20"rise		"	19	18	11	11	8	21 3/8
70-10",20"rise		"	17	18	9	11	10	21 3/8
70-12",20"rise		"	15	17	8	11	12	21 3/8
70-16",20"rise		"	15	15	7	7	16	21 3/8
74-2",20"rise	74min - 77"max	71	24	19	16	12	2	21 3/8
74-8",20"rise		"	21	19	12	12	8	21 3/8
74-10",20"rise		"	19	18	11	11	10	21 3/8
74-12",20"rise		"	17	18	9	11	12	21 3/8
74-16",20"rise		"	16	16	8	8	16	21 3/8
78-2",20"rise	78min - 81"max	75	28	19	19	12	2	21 3/8
78-8",20"rise		"	22	19	14	12	8	21 3/8
78-10",20"rise		"	21	19	12	12	10	21 3/8
78-12",20"rise		"	19	18	11	11	12	21 3/8
78-16",20"rise		"	14	17	7.5	11	16	21 3/8
82-2",20"rise	82min - 85"max	79	28	19	19	12	2	21 3/8
82-8",20"rise		"	24	19	16	12	8	21 3/8
82-10",20"rise		"	22	19	14	12	10	21 3/8
82-12",20"rise		"	21	19	12	12	12	21 3/8
82-16",20"rise		"	17	18	9	11	16	21 3/8
86-2",20"rise	86min - 89"max	83	31	19	22	12 1/2	2	21 3/8
86-8",20"rise		"	24	19	16	12	8	21 3/8
86-10",20"rise		"	24	19	16	12	10	21 3/8
86-12",20"rise		"	22	19	14	12	12	21 3/8
86-16",20"rise		"	19	18	11	11	16	21 3/8
90-2",20"rise	90min - 93"max	87	31	19	22	12 1/2	2	21 3/8
90-8",20"rise		"	28	19	19	12	8	21 3/8
90-10",20"rise		"	24	19	16	12	10	21 3/8
90-12",20"rise		"	24	19	16	12	12	21 3/8
90-16",20"rise		"	21	19	12	12	16	21 3/8
94-2",20"rise	94min - 97"max	91	34	19	25	13	2	21 3/8
94-8",20"rise		"	28	19	19	12	8	21 3/8
94-10",20"rise		"	28	19	19	12	10	21 3/8
94-12",20"rise		"	24	19	16	12	12	21 3/8
94-16",20"rise		"	22	19	14	12	16	21 3/8

** Outside Finished Width on Units with Horizontal Extensions differ from units without Horizontal Extensions.
Call for specific dimensions **

Eyebrow Horizontal Extensions Framing Specs- 20" Rise

Opening Model #	Rough Opening Width	Finished Opening Width	"A"	"B"	"C"	"D"	"E"	"F"
98-2",20"rise	98min - 101"max	95	34	19	25	13	2	21 3/8
98-8",20"rise		"	31	19	22	12 1/2	8	21 3/8
98-10",20"rise		"	28	19	19	12	10	21 3/8
98-12",20"rise		"	28	19	19	12	12	21 3/8
98-16",20"rise		"	24	19	16	12	16	21 3/8
102-2",20"rise	102"min - 105"max	99	36	19 1/2	26	13	2	21 3/8
102-8",20"rise		"	31	19	22	12 1/2	8	21 3/8
102-10",20"rise		"	31	19	22	12 1/2	10	21 3/8
102-12",20"rise		"	28	19	19	12	12	21 3/8
102-16",20"rise		"	24	19	16	12	16	21 3/8
106-2",20"rise	106"min - 109"max	103	36	19 1/2	26	13	2	21 3/8
106-8",20"rise		"	34	19	25	13	8	21 3/8
106-10",20"rise		"	31	19	22	12 1/2	10	21 3/8
106-12",20"rise		"	31	19	22	12 1/2	12	21 3/8
106-16",20"rise		"	28	19	19	12	16	21 3/8
110-2",20"rise	110" min - 113"max	107	39	19 1/2	28	14	2	21 3/8
110-8",20"rise		"	34	19	25	13	8	21 3/8
110-10",20"rise		"	34	19	25	13	10	21 3/8
110-12",20"rise		"	31	19	22	12 1/2	12	21 3/8
110-16",20"rise		"	28	19	19	12	16	21 3/8
114-2",20"rise	114" min - 117"max	111	39	19 1/2	28	14	2	21 3/8
114-8",20"rise		"	36	19 1/2	26	13	8	21 3/8
114-10",20"rise		"	34	19	25	13	10	21 3/8
114-12",20"rise		"	34	19	25	13	12	21 3/8
114-16",20"rise		"	31	19	22	12 1/2	16	21 3/8
118-2",20"rise	118"min - 121"max	115	42	20	30	14	2	21 3/8
118-8",20"rise		"	36	19 1/2	26	13	8	21 3/8
118-10",20"rise		"	36	19 1/2	26	13	10	21 3/8
118-12",20"rise		"	34	19	25	13	12	21 3/8
118-16",20"rise		"	31	19	22	12 1/2	16	21 3/8
122-2",20"rise	122"min - 125"max	119	42	20	30	14	2	21 3/8
122-8",20"rise		"	39	19 1/2	28	14	8	21 3/8
122-10",20"rise		"	36	19 1/2	26	13	10	21 3/8
122-12",20"rise		"	36	19 1/2	26	13	12	21 3/8
122-16",20"rise		"	34	19	25	13	16	21 3/8
126-2",20"rise	126" min- 129"max	123	45	20	31	14	2	21 3/8
126-8",20"rise		"	39	19 1/2	28	14	8	21 3/8
126-10",20"rise		"	39	19 1/2	28	14	10	21 3/8
126-12",20"rise		"	36	19 1/2	26	13	12	21 3/8
126-16",20"rise		"	34	19	25	13	16	21 3/8
130-2",20"rise	130" min - 133"max	127	45	20	31	14	2	21 3/8
130-8",20"rise		"	42	20	30	14	8	21 3/8
130-10",20"rise		"	39	19 1/2	28	14	10	21 3/8
130-12",20"rise		"	39	19 1/2	28	14	12	21 3/8
130-16",20"rise		"	36	19 1/2	26	13	16	21 3/8
134-2", 20" rise	134" min - 137"max	131	48	20	33	14	2	21 3/8
134-8", 20" rise		"	42	20	30	14	8	21 3/8
134-10", 20" rise		"	42	20	30	14	10	21 3/8
134-12", 20" rise		"	39	19 1/2	28	14	12	21 3/8
134-16", 20" rise		"	36	19 1/2	26	13	16	21 3/8

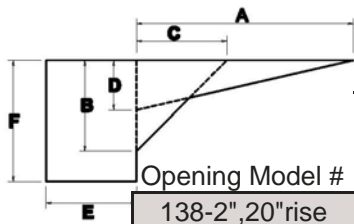

Eyebrow Horizontal Extensions Framing Specs - 20" Rise

Opening Model #	Rough Opening Width	Finished Opening Width	"A"	"B"	"C"	"D"	"E"	"F"
138-2",20"rise	138" min - 141" max	135	48	20	33	14	2	21 3/8
138-8",20"rise		"	45	20	31	14	8	21 3/8
138-10",20"rise		"	42	20	30	14	10	21 3/8
138-12",20"rise		"	42	20	30	14	12	21 3/8
138-16",20"rise		"	39	19 1/2	28	14	16	21 3/8
142-2",20"rise	142" min - 145" max	139	51	20	36	14	2	21 3/8
142-8",20"rise		"	45	20	31	14	8	21 3/8
142-10",20"rise		"	45	20	31	14	10	21 3/8
142-12",20"rise		"	42	20	30	14	12	21 3/8
142-16",20"rise		"	39	19 1/2	28	14	16	21 3/8
146-2",20"rise	146" min - 149" max	143	51	20	36	14	2	21 3/8
146-8",20"rise		"	48	20	33	14	8	21 3/8
146-10",20"rise		"	45	20	31	14	10	21 3/8
146-12",20"rise		"	45	20	31	14	12	21 3/8
146-16",20"rise		"	42	20	30	14	16	21 3/8
150-2",20"rise	150" min - 153" max	147	54	20	39	14	2	21 3/8
150-8",20"rise		"	48	20	33	14	8	21 3/8
150-10",20"rise		"	48	20	33	14	10	21 3/8
150-12",20"rise		"	45	20	31	14	12	21 3/8
150-16",20"rise		"	42	20	30	14	16	21 3/8
154-2",20"rise	154" min - 157"max	151	54	20	39	14	2	21 3/8
154-8",20"rise		"	51	20	36	14	8	21 3/8
154-10",20"rise		"	48	20	33	14	10	21 3/8
154-12",20"rise		"	48	20	33	14	12	21 3/8
154-16",20"rise		"	45	20	31	14	16	21 3/8
158-2",20"rise	158" min - 161" max	155	54	20	39	14	2	21 3/8
158-8",20"rise		"	51	20	36	14	8	21 3/8
158-10",20"rise		"	51	20	36	14	10	21 3/8
158-12",20"rise		"	48	20	33	14	12	21 3/8
158-16",20"rise		"	45	20	31	14	16	21 3/8
162-2",20"rise	162" min - 165" max	159	60	20	43	14	2	21 3/8
162-8",20"rise		"	54	20	39	14	8	21 3/8
162-10",20"rise		"	51	20	36	14	10	21 3/8
162-12",20"rise		"	51	20	36	14	12	21 3/8
162-16",20"rise		"	48	20	33	14	16	21 3/8
166-2",20"rise	166" min - 169" max	163	60	20	43	14	2	21 3/8
166-8",20"rise		"	54	20	39	14	8	21 3/8
166-10",20"rise		"	54	20	39	14	10	21 3/8
166-12",20"rise		"	51	20	36	14	12	21 3/8
166-16",20"rise		"	48	20	33	14	16	21 3/8
170-2",20"rise	170" min - 173" max	167	60	20	43	14	2	21 3/8
170-8",20"rise		"	54	20	39	14	8	21 3/8
170-10",20"rise		"	54	20	39	14	10	21 3/8
170-12",20"rise		"	54	20	39	14	12	21 3/8
170-16",20"rise		"	51	20	36	14	16	21 3/8

** Outside Finished Width on Units with Horizontal Extensions differ from units without Horizontal Extensions.
Call for specific dimensions **